

TABLE OF CONTENTS

PAGE	SUBJECT	DATE
1	Notebook Set-up	4/29/15
2	Notebook Set-up (cont.)	4/29/15
3	Team Biography	4/29/15
4	Team Biography (cont.)	4/29/15
5	VEX Nothing But Net: 2015-2016	4/30/15
6	VEX Nothing But Net Rules	4/30/15
7	VEX Nothing But Net Rules (cont.)	4/30/15
8	VEX Nothing But Net Rules (cont.)	4/30/15
9	VEX Nothing But Net Rules (cont.)	4/30/15
10	VEX Nothing But Net Rules (cont.)	4/30/15
11	VEX Nothing But Net Rules (cont.)	4/30/15
12	VEX Nothing But Net Rules (cont.)	4/30/15
13	VEX Nothing But Net Rules (cont.)	4/30/15
14	VEX Nothing But Net Rules (cont.)	4/30/15
15	VEX Nothing But Net Rules (cont.)	4/30/15
16	VEX Nothing But Net Rules (cont.)	4/30/15
17	VEX Nothing But Net Rules (cont.)	4/30/15
18	VEX Nothing But Net Rules (cont.)	4/30/15
19	VEX Nothing But Net Field Measurements	4/30/15
20	VEX Nothing But Net Field Measurements (cont.)	4/30/15
21	VEX Nothing But Net Field Measurements (cont.)	4/30/15
22	Season Gantt Chart	4/30/15
23	Season Schedule Breakdown (cont.)	4/30/15
24	May Schedule	5/1/15
25	VEX Nothing But Net: Objective and Obstacles	5/5/15
26	VEX Nothing But Net: Objective and Obstacles (cont.)	5/5/15
27	VEX Nothing But Net: Objective and Obstacles (cont.)	5/5/15
28	Goal Prioritization	5/7/15
29	Last Resorts	5/7/15
30	Last Resorts (cont.)	5/7/15
31	Design Brainstorm	5/12/15
32	Design Brainstorm (cont.)	5/12/15

TABLE OF CONTENTS

PAGE	SUBJECT	DATE
33	Design Brainstorm (cont.)	5/12/15
34	Design Brainstorm Day 2	5/14/15
35	Scissor Base Concept	5/14/15
36	General Prototype Designs	5/19/15
37	General Prototype Designs (cont.)	5/19/15
38	General Prototyping Day 2	5/21/15
39	General Prototyping Day 2 (cont.)	5/21/15
40	General Prototyping Day 3	5/26/15
41	General Prototyping Day 3 (cont.)	5/26/15
42	General Prototyping Day 3 (cont.)	5/26/15
43	General Prototyping Day 4	5/28/15
44	General Prototyping Day 4 (cont.)	5/28/15
45	General Prototyping Day 4 (cont.)	5/28/15
46	June Schedule	6/1/15
47	General Prototyping Day 5	6/2/15
48	General Prototyping Day 5 (cont.)	6/2/15
49	General Prototyping Day 5 (cont.)	6/2/15
50	General Prototyping Day 6	6/4/15
51	CADD day 1	6/10/15
52	CADD day 1 cont	6/10/15
53	CADD day 1 cont	6/10/15
54	CADD day 2	6/17/15
55	CADD day 2 cont	6/17/15
56	CADD day 3	6/24/15
57	CADD day 3 cont	6/24/15
58	July Schedule	7/1/15
59	CADD Day 4	7/1/15
60	CADD Day 5	7/8/15
61	CADD Day 6/Specific Prototype Day 1	7/15/15
62	CADD Day 6/Specific Prototype Day 1 (cont.)	7/15/15
63	Summer Camp Research	7/16/15
64	Summer Camp Research (cont.)	7/16/15

TABLE OF CONTENTS

PAGE	SUBJECT	DATE
65	Summer Camp Research (cont.)	7/16/15
66	CADD Day 7	7/22/15
67	CADD Day 7(cont.)	7/22/15
68	Summer Camp Research 2	7/23/15
69	Summer Camp Research 2(cont.)	7/23/15
70	Summer Camp Research 2(cont.)	7/23/15
71	CADD Day 8	7/29/15
72	CADD Day 8(cont.)	7/29/15
73	August Schedule	8/1/15
74	CADD Day 9	8/5/15
75	CADD Day 9(cont.)	8/5/15
76	CADD Day 10	8/12/15
77	CADD Day 10 (cont.)	8/12/15
78	CADD Day 11	8/19/15
79	CADD Day 11 (cont.)	8/19/15
80	CADD Day 12	8/26/15
81	CADD Day 12 (cont.)	8/26/15
82	September Schedule	9/1/15
83	Scissor Base Testing	9/1/15
84	Brainstorming 2	9/2/15
85	Brainstorming 2 (cont.)	9/2/15
86	Brainstorming 2 (cont.)	9/2/15
87	Design Decisions	9/3/15
88	Design Decisions (cont.)	9/3/15
89	Design Decisions (cont.)	9/3/15
90	Design Decisions (cont.)	9/3/15
91	Design Decisions (cont.)	9/3/15
92	Design Decisions (cont.)	9/3/15
93	Design Decisions (cont.)	9/3/15
94	Build Day 1	9/8/15
95	Build Day 1(cont.)	9/8/15
96	Build Day 2/Programming Day 1	9/9/15

TABLE OF CONTENTS

PAGE	SUBJECT	DATE
97	Build Day 2(cont.)	9/9/15
98	Programming Day 1: Motor Port Layout	9/9/15
99	Build Day 3	9/10/15
100	Build Day 4	9/11/15
101	Build Day 5	9/14/15
102	Build Day 5(cont.)	9/14/15
103	Build Day 6	9/15/15
104	Build Day 6(cont.)	9/15/15
105	Build Day 7	9/16/15
106	Build Day 7(cont.)	9/16/15
107	Build Day 7(cont.)	9/16/15
108	Build Day 8	9/17/15
109	Build Day 9	9/18/15
110	Build Day 10/Programming Day 2	9/21/15
111	Build Day 10/Programming Day 2(cont.)	9/21/15
112	Programming Day 2: Motor Port Layout	9/21/15
113	Build Day 11/Programming Day 3	9/23/15
114	Build Day 11/Programming Day 3(cont.)	9/23/15
115	Build Day 12/Programming Day 4	9/25/15
116	Build Day 13	9/28/15
117	Build Day 13(cont.)	9/28/15
118	Build Day 14	9/29/15
119	Build Day 15	9/30/15
120	October Schedule	10/1/15
121	Build Day 16/Programming Day 5	10/1/15
122	Build Day 17/Programming Day 6	10/5/15
123	Build Day 17/Programming Day 6(cont.)	10/5/15
124	Ball Mass Variance	10/6/15
125	Programming Day 7	10/7/15
126	Build Day 18	10/8/15
127	Build Day 18(cont.)	10/8/15
128	Build Day 19/Programming Day 8	10/9/15

TABLE OF CONTENTS

PAGE	SUBJECT	DATE
129	Build Day 19/Programming Day 8(cont.)	10/9/15
130	Build Day 20	10/12/15
131	Build Day 20(cont.)	10/12/15
132	Build Day 20(cont.)	10/12/15
133	Build Day 21/Programming Day 9	10/14/15
134	Programming Day 9: Motor Port Layout	10/14/15
135	Build Day 22/Programming Day 10	10/15/15
136	Build Day 22/Programming Day 10 (cont.)	10/15/15
137	Build Day 23/Programming Day 11	10/16/15
138	Stanley Shi Research	10/16/15
139	Build Day 24	10/19/15
140	Build Day 24(cont.)	10/19/15
141	Build Day 25/Programming Day 12	10/20/15
142	Build Day 25/Programming Day 12(cont.)	10/20/15
143	Build Day 26	10/21/15
144	Build Day 27	10/22/15
145	Build Day 27(cont.)	10/22/15
146	Build Day 28	10/26/15
147	Build Day 28	10/26/15
148	Build Day 29/Programming Day 13	10/27/15
149	Programming Day 13: Motor Port Layout	10/27/15
150	Build Day 30/Programming Day 14	10/28/15
151	Build Day 31/Programming Day 15	10/29/15
152	Build Day 31/Programming Day 15(cont.)	10/29/15
153	Build Day 32/Programming Day 16	10/30/15
154	Build Day 32/Programming Day 16 (cont.)	10/30/15
155	October 31, 2015: Potomac High School Competition	10/31/15
156	October 31, 2015: Potomac High School Competition (cont.)	10/31/15
157	October 31, 2015: Potomac High School Competition (cont.)	10/31/15
158	November 2, 2015: Post-Competition Reflection	11/2/15
159	November 2, 2015: Post-Competition Reflection (cont.)	11/2/15
160	November 2, 2015: Post-Competition Reflection (cont.)	11/2/15

TABLE OF CONTENTS

PAGE	SUBJECT	DATE
161	November 2, 2015: Post-Competition Reflection (cont.)	11/2/15
162	November 2, 2015: Post-Competition Reflection (cont.)	11/2/15
163	Statistics for Potomac High School Competition	11/2/15
164	Statistics for Potomac High School Competition (cont.)	11/2/15
165	Statistics for Potomac High School Competition (cont.)	11/2/15
166	November Schedule	11/2/15
167	Build Day 33	11/3/15
168	Build Day 33 (cont.)	11/3/15
169	Build Day 33 (cont.)	11/3/15
170	Build Day 34/Programming Day 17	11/4/15
171	Build Day 34/Programming Day 17 (cont.)	11/4/15
172	Build Day 35/Programming Day 18	11/5/15
173	Build Day 36	11/6/15
174	Build Day 36 (cont.)	11/6/15
175	Build Day 37 ^{AA}	11/9/15
176	Build Day 37 (cont.)	11/9/15
177	Build Day 37 (cont.)	11/9/15
178	Build Day 38	11/10/15
179	Build Day 38 (cont.)	11/10/15
180	Build Day 39	11/12/15
181	Build Day 39 (cont.)	11/12/15
182	Build Day 40/Programming Day 19/Efficiency Test 1	11/13/15
183	Build Day 40/Programming Day 19/Efficiency Test 1 (cont.)	11/13/15
184	Build Day 40/Programming Day 19/Efficiency Test 1 (cont.)	11/13/15
185	Programming Day 19: Motor & Sensor Port Layout	11/13/15
186	Programming Day 19: Motor & Sensor Port Layout (cont.)	11/13/15
187	Build Day 41/Programming Day 20	11/14/15
188	Build Day 41/Programming Day 20 (cont.)	11/14/15
189	Build Day 41/Programming Day 20 (cont.)	11/14/15
190	Build Day 42/Programming Day 21	11/16/15
191	Build Day 42/Programming Day 21 (cont.)	11/16/15
192	Programming Day 21: Motor & Sensor Port Layout	11/16/15

TABLE OF CONTENTS

PAGE	SUBJECT	DATE
193	Build Day 43	11/7/15
194	Build Day 43(cont.)	11/7/15
195	Build Day 44	11/8/15
196	Build Day 44(cont.)	11/8/15
197	Build Day 45/Programming Day 22	11/19/15
198	Build Day 45/Programming Day 22(cont.)	11/19/15
199	Build Day 46/Programming Day 23	11/20/15
200	Build Day 46/Programming Day 23(cont.)	11/20/15
201	November 21, 2015: Woodrow Wilson High School Competition	11/21/15
202	November 21, 2015: Woodrow Wilson High School Competition(cont.)	11/21/15
203	November 21, 2015: Woodrow Wilson High School Competition(cont.)	11/21/15
204	November 23, 2015: Post Competition Reflection	11/23/15
205	November 23, 2015: Post Competition Reflection(cont.)	11/23/15
206	November 23, 2015: Post Competition Reflection(cont.)	11/23/15
207	Statistics for Woodrow Wilson High School Competition	11/23/15
208	Statistics for Woodrow Wilson High School Competition(cont.)	11/23/15
209	Statistics for Woodrow Wilson High School Competition(cont.)	11/23/15
210	Build Day 47 / Project WELP Day 1	11/24/15
211	Build Day 47/ Project WELP Day 1 (cont.)	11/24/15
212	Build Day 47/ Project WELP Day 1 (cont.)	11/24/15
213	Build Day 47 / Project WELP Day 1 (cont.)	11/24/15
214	Project WELP Frictionless Slide CADs	11/24/15
215	Project WELP ^A Build Day 47/Project WELP Day 1 (cont.)	11/24/15
216	Build Day 47/ Project WELP Day 1 (cont.)	11/24/15
217	Build Day 48/Project WELP Day 2	11/30/15
218	December Schedule	12/1/15
219	Project WELP Day 3	12/1/15
220	Project WELP Day 3 (cont.)	12/1/15
221	Project WELP Day 3 (cont.)	12/1/15
222	Project WELP Day 3 (cont.)	12/1/15
223	Project WELP Day 4/Programming Day 24/CADD Day 13	12/2/15
224	Project WELP Day 4/Programming Day 24/CADD Day 13(cont.)	12/2/15

TABLE OF CONTENTS

PAGE	SUBJECT	DATE
225	Project WELP Day 4/Programming Day 24/CADD Day 13 (cont.)	12/2/15
226	Project WELP Day 5/Programming Day 25/Build Day 49	12/3/15
227	Project WELP Day 5/Programming Day 25/Build Day 49 (cont.)	12/3/15
228	Project WELP Day 5/Programming Day 25/Build Day 49 (cont.)	12/3/15
229	Build Day 50	12/4/15
230	Build Day 50 (cont.)	12/4/15
231	December 5 th , 2015: Woodbridge Senior High School Competition	12/5/15
232	December 5 th , 2015: Woodbridge Senior High School Competition (cont.)	12/5/15
233	December 5 th , 2015: Woodbridge Senior High School Competition (cont.)	12/5/15
234	December 7, 2015: Post-Competition Reflection	12/7/15
235	December 7, 2015: Post-Competition Reflection	12/7/15
236	December 7, 2015: Post-Competition Reflection (cont.)	12/7/15
237	Statistics for Woodbridge Senior High School Competition	12/7/15
238	Statistics for Woodbridge Senior High School Competition (cont.)	12/7/15
239	Build Day 51/CADD Day 14	12/9/15
240	Build Day 51/CADD Day 14 (cont.)	12/9/15
241	Build Day 52	12/10/15
242	Build Day 52 (cont.)	12/10/15
243	Build Day 53	12/11/15
244	Build Day 54	12/14/15
245	Build Day 54 (cont.)	12/14/15
246	Build Day 55	12/15/15
247	Build Day 55 (cont.)	12/15/15
248	Build Day 56/Programming Day 26	12/16/15
249	Build Day 56/Programming Day 26 (cont.)	12/16/15
250	Build Day 57 / CADD Day 14	12/17/15
251	Full-Court WELP Shooter CADD	12/17/15
252	Build Day 57 / CADD Day 14 (cont.)	12/17/15
253	Build Day 58	12/18/15
254	Build Day 59	12/19/15
255	Build Day 59 (cont.)	12/19/15
256	Build Day 59 (cont.)	12/19/15

TABLE OF CONTENTS

PAGE	SUBJECT	DATE
257	Build Day 60	12/20/15
258	Build Day 60 (cont.)	12/20/15
259	Build Day 61	12/21/15
260	Build Day 61 (cont.)	12/21/15
261	Build Day 62 / CADD Day 15	12/22/15
262	Light Bar Shooter CADs	12/22/15
263	Light Bar Shooter CADs (cont.)	12/22/15
264	Build Day 62 / CADD Day 15 (cont.)	12/22/15
265	Build Day 63 / CADD Day 16	12/23/15
266	Build Day 63 / CADD Day 16 (cont.)	12/23/15
267	Bar Shooter Decision Matrix	12/23/15
268	Build Day 63 / CADD Day 16 (cont.)	12/23/15
269	Build Day 63 / CADD Day 16 (cont.)	12/23/15
270	Build Day 64	12/24/15
271	Build Day 65	12/25/15
272	Build Day 65 (cont.)	12/25/15
273	Build Day 66	12/26/15
274	Build Day 66 (cont.)	12/26/15
275	Build Day 67	12/28/15
276	Build Day 68 (cont.)	12/28/15
277	Build Day 69	12/29/15
278	Build Day 69 (cont.)	12/29/15
279	Build Day 69 (cont.)	12/29/15
280	Build Day 70	12/30/15
281	Build Day 71 / Programming Day 27	1/4/16
282	Programming Day 27: Motor & Sensor Port Layout	1/4/16
283	Build Day 71 / Programming Day 27 (cont.)	1/4/16
284	Build Day 72	1/5/16
285	Build Day 72 (cont.)	1/5/16
286	Build Day 73	1/7/16
287	Build Day 74 / Programming Day 28	1/8/16
288	Build Day 74 / Programming Day 28 (cont.)	1/8/16

TABLE OF CONTENTS

PAGE	SUBJECT	DATE
1	Statistics for USPTO Competition (cont.)	1/18/16
2	Build Day 77	1/19/16
3	Build Day 77 (cont.)	1/19/16
4	Build Day 78	1/20/16
5	Build Day 79	1/28/16
6	Build Day 79(cont.)	1/28/16
7	Build Day 80/Programming Day 30	1/29/16
8	January 30 th , 2016: Germana Community college Competition	1/30/16
9	January 30 th , 2016: Germana Community College Competition (Cont.)	1/30/16
10	January 30 th , 2016: Germana Community College Competition (cont.)	1/30/16
11	January 30 th , 2016: Germana Community College Competition (cont.)	1/30/16
12	February 1 st , 2016: Post-Competition Reflection Personal Statements	2/1/16
13	February 1 st , 2016: Post-Competition Reflection (cont.)	2/1/16
14	February 1 st 2016: Post Competition Reflection (Cont.)	2/1/16
15	Statistics for Germana Community College Competition	2/1/16
16	Statistics for Germana Community College Competition (cont.)	2/1/16
17	Build Day 80^{AA} Specific Prototyping 2.0 day 1	2/2/16
18	Specific Prototyping 2.0 Day 1 (cont.)	2/2/16
19	Specific Prototyping 2.0 Day 1 (cont.)	2/2/16
20	Specific Prototyping 2.0 Day 2	2/3/16
21	Specific Prototyping 2.0 Day 2 (cont.)	2/3/16
22	Skills Competition at Woodbridge Senior High School	2/4/16
23	Skills Competition at Woodbridge Senior High School (cont.)	2/4/16
24	Specific Prototyping 2.0 Day 3	2/5/16
25	February 6 th , 2016: Mount Vernon High School Competition	2/6/16
26	February 6 th , 2016: Mount Vernon High School Competition (cont.)	2/6/16
27	February 6 th , 2016: Mount Vernon High School Competition (cont.)	2/6/16
28	February 6 th , 2016: Post Competition Reflection	2/8/16
29	February 8 th , 2016: Post Competition Reflection (cont.)	2/8/16
30	February 9 th , 2016: Post Competition Reflection (cont.)	2/8/16
31	Specific Prototyping 2.0 Day 4	2/9/16
32	Specific Prototyping 2.0 Day 4 (cont.)	2/9/16

TABLE OF CONTENTS

PAGE	SUBJECT	DATE
33	CAD Day 17 Specific Prototyping 2.0 Day 4 (cont.)	2/9/16
34	CAD Day 17 (cont.)	2/9/16
35	CAD Day 17 (cont.)	2/9/16
36	Statistics for Mt. Vernon High School Competition	2/9/16
37	Statistics for Mt. Vernon High School Competition (cont.)	2/9/16
38	Specific Prototyping Day 5 2.0	2/10/16
39	Specific Prototyping Day 5 2.0 (cont.)	2/10/16
40	Specific Prototyping Day 6 2.0	2/11/16
41	Specific Prototyping Day 6 2.0 (cont.)	2/11/16
42	Specific Prototyping Day 6 2.0 (cont.)	2/11/16
43	Specific Prototyping Day 7 2.0	2/12/16
44	Specific Prototyping Day 7 2.0 (cont.)	2/12/16
45	Specific Prototyping Day 8 2.0	2/13/16
46	Specific Prototyping Day 8 2.0 (cont.)	2/13/16
47	Specific Prototyping Day 8 2.0 (cont.)	2/13/16
48	Specific Prototyping Day 9 2.0	2/14/16
49	Specific Prototyping Day 9 2.0 (cont.)	2/14/16
50	Specific Prototyping Day 9 2.0 (cont.)	2/14/16
51	Specific Prototyping Day 9 2.0 (cont.)	2/14/16
52	Specific Prototyping 2.0: Motor and Sensor port layout	2/14/16
53	Specific Prototyping Day 10 2.0	2/17/16
54	Specific Prototyping Day 10 2.0 (cont.)	2/17/16
55	Specific Prototyping Day 10 2.0 (cont.)	2/17/16
56	Specific Prototyping Day 11 2.0	2/18/16
57	Specific Prototyping Day 11 2.0 (cont.)	2/18/16
58	February 20 th , 2016: VA State Competition	2/20/16
59	February 20 th , 2016: VA State Competition (cont.)	2/20/16
60	February 20 th , 2016: VA State Competition (cont.)	2/20/16
61	February 20 th , 2016: VA State Competition (cont.)	2/20/16
62	February 22 nd , 2016: Post-Competition Reflection	2/22/16
63	February 22 nd , 2016: Post-Competition Reflection (cont.)	2/22/16
64	February 22 nd , 2016: Post-Competition Reflection (cont.)	2/22/16

TABLE OF CONTENTS

PAGE	SUBJECT	DATE
65	February 22 nd , 2016: Post-Competition Reflection (cont.)	2/22/16
66	Statistics for VA State Championship	2/22/16
67	Statistics for VA State Championship (cont.)	2/22/16
68	Specific Prototyping 2.0 Day 12 / Specific Prototyping 3.0 Day 1	2/22/16
69	Specific Prototyping 2.0 Day 12 / Specific Prototyping 3.0 Day 1 (cont.)	2/22/16
70	Design Decisions (cont.)	2/22/16
71	Design Decisions (cont.)	2/22/16
72	Design Decisions (cont.)	2/22/16
73	Specific Prototyping 3.0 Day 2	2/23/16
74	Specific Prototyping 3.0 Day 2 (cont.)	2/23/16
75	Specific Prototyping 3.0 Day 3	2/24/16
76	Specific Prototyping 3.0 Day 3 (cont.)	2/24/16
77	Specific Prototyping 3.0 Day 4	2/25/16
78	Specific Prototyping 3.0 Day 4 (cont.)	2/25/16
79	Specific Prototyping 3.0 Day 5	2/26/16
80	Specific Prototyping 3.0 Day 6	2/29/16
81	Specific Prototyping 3.0 Day 6 (cont.)	2/29/16
82	March Schedule	3/1/16
83	Specific Prototyping 3.0 Day 7	3/2/16
84	Specific Prototyping 3.0 Day 7 (cont.)	3/2/16
85	Specific Prototype 3.0 Day 8	3/3/16
86	Specific Prototype 3.0 Day 9	3/4/16
87	Specific Prototype 3.0 Day 10	3/7/16
88	Specific Prototype 3.0 Day 10 (cont.)	3/7/16
89	Specific Prototype 3.0 Day 11	3/8/16
90	Specific Prototype 3.0 Day 11 (cont.)	3/8/16
91	Specific Prototype 3.0 Day 12	3/9/16
92	Specific Prototype 3.0 Day 12 (cont.)	3/9/16
93	Specific Prototype 3.0 Day 13	3/10/16
94	Specific Prototype 3.0 Day 13 (cont.)	3/10/16
95	Specific Prototyping 3.0 Day 14	3/11/16
96	Specific Prototyping 3.0 Day 14 (cont.)	3/11/16

TABLE OF CONTENTS

PAGE	SUBJECT	DATE
97	Specific Prototype 3.0 Day 15	3/14/16
98	Specific Prototype 3.0 Day 15 (cont.)	3/14/16
99	Specific Prototype 3.0 Day 16	3/15/16
100	Specific Prototype 3.0 Day 16 (cont.)	3/15/16
101	Specific Prototype 3.0 Day 17	3/16/16
102	Specific Prototype 3.0 Day 18	3/17/16
103	Specific Prototype 3.0 Day 19	3/18/16
104	Specific Prototype 3.0 Day 20	3/19/16
105	Specific Prototype 3.0 Day 20 (cont.)	3/19/16
106	Specific Prototype 3.0 Day 21	3/21/16
107	Specific Prototype 3.0 Day 21 (cont.)	3/21/16
108	Specific Prototype 3.0 Day 22	3/29/16
109	Specific Prototype 3.0 Day 23	3/30/16
110	Specific Prototype 3.0 Day 24	3/31/16
111	Specific Prototype 3.0 Day 25	4/1/16
112	Specific Prototype 3.0 Day 25 (cont.)	4/1/16
113	Specific Prototype 3.0 Day 25 (cont.)	4/1/16
114	Specific Prototype 3.0 Day 26	4/4/16
115	Specific Prototype 3.0 Day 27	4/5/16
116	Specific Prototype 3.0 Day 27 (cont.)	4/5/16
117	Specific Prototype 3.0 Day 28	4/6/16
118	Specific Prototype 3.0 Day 29	4/7/16
119	Specific Prototype 3.0 Day 30	4/8/16
120	Specific Prototype 3.0 Day 30 (cont.)	4/8/16
121	Specific Prototype 3.0 Day 31	4/11/16
122	Specific Prototype 3.0 Day 31 (cont.)	4/11/16
123	Specific Prototype 3.0 Day 32	4/12/16
124	Specific Prototype 3.0 Day 32 (cont.)	4/12/16
125	Specific Prototype 3.0 Day 33	4/13/16
126	Build day 81	4/14/16
127	Build day 81 (cont.)	4/14/16
128	Build day 82	4/15/16

TABLE OF CONTENTS

PAGE	SUBJECT	DATE
129	Build day 82 (cont)	4/15/16
130	Build day 83 / Programming Day 31	4/16/16
131	Build day 83 / Programming Day 31 (cont)	4/16/16
132	Programming day 32	4/18/16
133	Programming day 32 (cont)	4/18/16
134		
135		
136		
137		
138		
139		
140		
141		
142		
143		
144		
145		
146		
147		
148		
149		
150		
151		
152		
153		
154		
155		
156		
157		
158		
159		
160		

Notebook Set-up

4/29/15

• Example Notebook Page

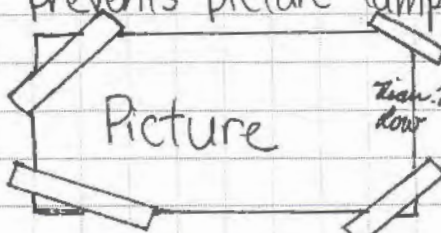
<u>Title</u>	Page Number
<u>Date</u>	
<ul style="list-style-type: none"> • Bullets are topics and main ideas. • Bullet points indented by one half of a square are subjects of the topic above. • For example. • And further example. • If there is a mistake, cross it out and ^{add} the correct version next to or around the mistake. The mistake must be initialled by the captain. • An example is shown above with the correction to the word "add." 	
<ul style="list-style-type: none"> • Pictures • Pictures will be taped in with four pieces of tape in the corners. Also, every picture must be signed and dated with half of the signature on the picture and half of it off. This prevents picture tampering. 	
 <p>* Any asterisk bullet represents an especially important event.</p>	
<ul style="list-style-type: none"> • At the bottom of the page, the entry writer and supervisor must sign. 	
Supervising Engineer	4/29/15
4/29/15	

Continued to page 2

SIGNATURE

DATE

4/29/15

DISCLOSED TO AND UNDERSTOOD BY

DATE

Notebook Set-up (cont.)

4/29/15

- Example notebook page (cont.)

2 Example Page

- Sketches

- In the sketches, there will be labels. Arrows will be drawn to the specific parts, or a key will be provided.

An example is shown below.

SKETCH ^{of the letter "H"}

Key
- The letter "K"
- The letter "E"
- Surrounding letters

- When a page is referred to, the first number represents the notebook number, and the second number represents the page number. They are separated by a dash. For example; "Refer to pg. 1-1" would refer to the previous page, because it is in the first notebook and is labeled 1.

- When there is open space, put one line through it and sign it.

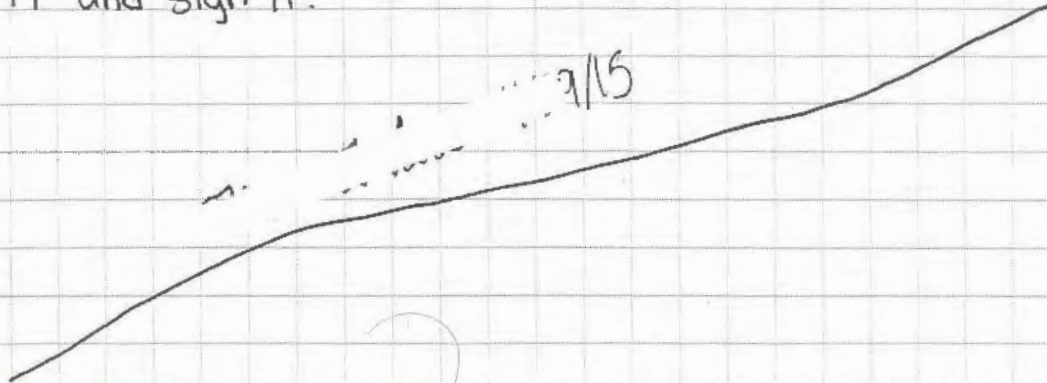

Superwising Engineer

4/29/15

4/29/15

Continued to page

SIGNATURE

DISCLOSED TO AND UNDERSTOOD BY

AM

DATE

4/29/15

DATE

4/29/15

PROPRIETARY INFORMATION

Season Gantt Chart

4/30/15

VEX Nothing But Net Season Schedule by Days

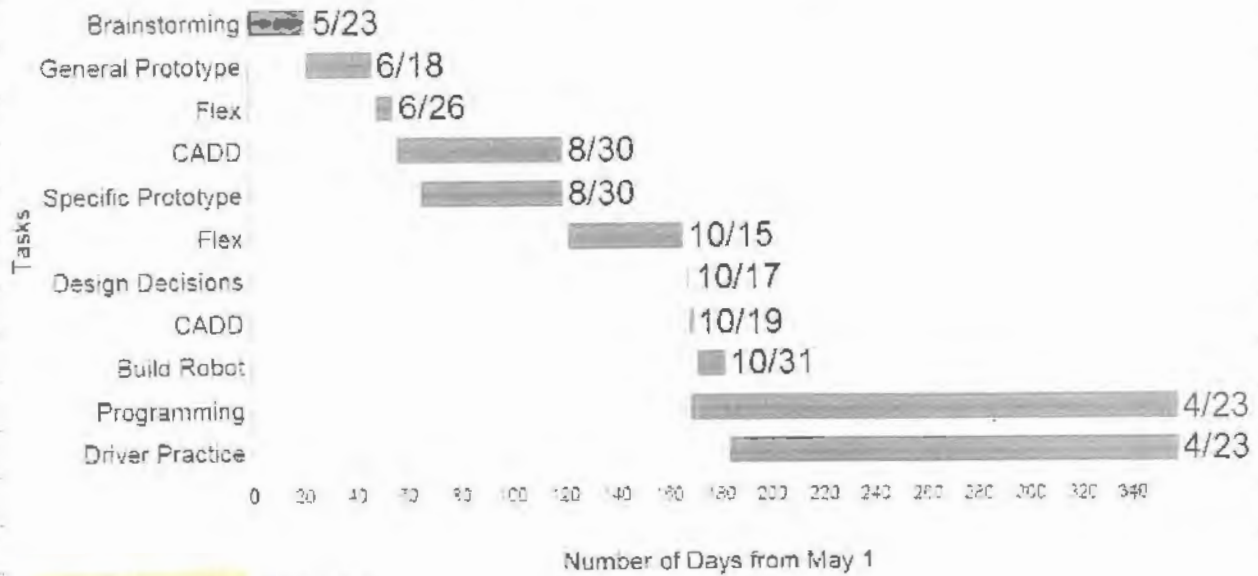

Season Schedule Breakdown

- To start off the year, we set deadlines for various steps of the building process.
 - 1) From 5/1 to 5/23, we will be brainstorming ideas, through Google Hangouts or at school. Typically this step would usually take one week. However, less members will come at the end of the school year. Furthermore, we will only meet twice per week. To compensate, we will devote 8 days to brainstorm (strategies, designs, etc.) This will allow members to have less of a workload during final exam time, and recuperate from last year's season, VEX Skyrise. The team may CAD if needed.
 - 2) During 5/24-6/18, our members will work individually on the ideas discussed during the brainstorm. Our aim is to construct a diverse array of designs and see which will be most reliable. During 6/19-6/26 h.h.
 - 3) This time allows the members to continue trying different designs or to start improving their previous design(s).

Continued to page 1-23

SIGNATURE

DATE

4/30/15

DISCLOSED TO AND UNDERSTOOD BY

DATE

4/30/15

PROPRIETARY INFORMATION

May Schedule

5/1/15

May 2015

Sun	Mon	Tue	Wed	Thu	Fri	Sat
					1	2
3	4	5 Discuss Main Goals of Game & Obstacles	6	7 Rank Goals by Importance Discuss "Last Resorts"	8 FLL Competition Volunteering	9 FLL Competition Volunteering
10 Monday	11	12 Brainstorm Field Strategies	13	14 Brainstorm Designs	15 Robotics Volunteering	16 Robotics Volunteering
17	18	19 Brainstorm Designs	20	21 Brainstorm Designs	22	23
24	25 Monday Day	26 Build Designs	27	28 Build Designs	29	30
31						

5/1/15

May Schedule

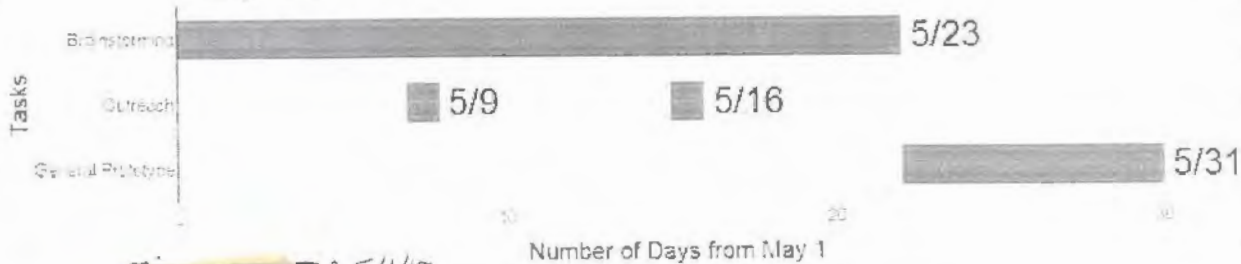

* To maintain a professional, scientific outlook in the notebook, outreach days will only be included in the binder. However, they will still be listed in the Gantt charts and calendars to keep track of our entire schedule.

Continued to page

SIGNATURE 	DATE 5/1/15
DISCLOSED TO AND UNDERSTOOD BY bi	DATE 5/1/15
PROPRIETARY INFORMATION	

VEX Nothing But Net: Objective and Obstacles

5/5/15

A.A.
A.A.

- Objective for Today: Discuss Game Objective and Obstacles
- Objective of Game Discussion

- Above all else, the robot's goal is to score more points than the opposite alliance, with a partner of its own. However, this can be interpreted two ways:
 - 1) Score as many points as possible, or
 - 2) Prevent the opposing alliance from scoring.
- Another goal is to win the autonomous period. In this period, there are no points for low or high elevation, so winning autonomous can be interpreted as scoring ~~45~~⁴⁴ ~~more~~ points with balls or bonus balls than the opposing alliance.
- There are two ways to score points in a match:
 - 1) Getting Balls or Bonus Balls in the Goal - The robot must "throw" the ball or bonus ball higher than 7.38" for the low goal. However, to get above the pipe brackets on either side of the pipe, the ball or bonus ball must be over 7.46". The robot must "throw" the ball length-wise between 21.87"-33.45" and height-wise 36.16"-45.24" above the ground. Taking the robot's maximum height into account, the shortest possible distance to "throw" the ball into the middle of the high goal (the safest way to prevent the ball from bouncing off the net) is approximately 35.78". The calculations are shown on pg. 1-26.
 - 2) Elevation - The robot and its alliance partner must be stacked, such that one robot is above 4" for low elevation and above 12" for high elevation.

• Obstacles of Game Discussion

- Size Limit - Unlike other competitions, Nothing But Net prohibits expanding past the size limit for certain areas and time. This makes high goal scoring more difficult.
- Rule SGA (on pg. 1-10) - This rule prevents robots

Continued to page 1-26

SIGNATURE

DATE

5/5/15

DISCLOSED TO AND UNDERSTOOD BY

DATE

5/5/15

PROPRIETARY INFORMATION

VEX Nothing But Net: Objective and Obstacles (cont.)

5/5/15

• Obstacles of Game Discussion (cont.)

From ramming balls or bonus balls under the pipe.

- Rule 568 (on pg. 1-10) - This prevents robots from hoarding balls or scoring many balls at once.

• Shortest High Goal Throwing Distance Calculations



- These are the field measurements provided by VEX (also shown on pg. 1-20 and pg. 1-21), also on www.vexrobotics.com.
- Middle of High Goal Calculations
 $11.58 \div 2 = 5.79$
 $(36.16 + 45.24) = \frac{81.4}{2} = \boxed{40.7}$

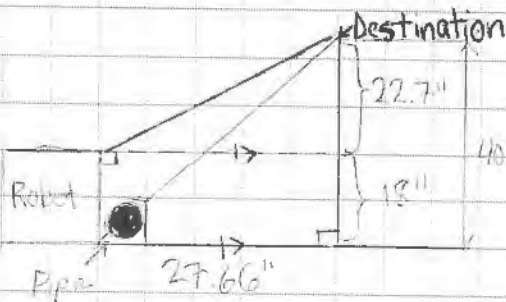

- From the intersection of the perimeter's corner and the ground, the destination point is 5.79" across and 40.7" high.
- After finding the destination point, we can find the horizontal and vertical distance.
 Horizontal: $3.5 + 18.37 + 5.79 = \boxed{27.66}$
 Vertical: $40.7 - 18 (\text{Robot Max Height}) = \boxed{22.7}$

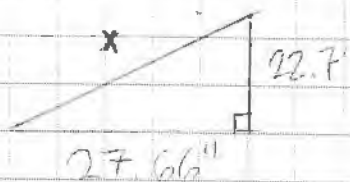

• Final Calculations

$$a^2 + b^2 = c^2$$

$$22.7^2 + 27.66^2 = x^2$$

$$515.29 + 765.0756 = x^2$$

$$1280.3656 = x^2$$

$$x \approx \pm 35.78$$

Distance cannot be negative, so the shortest distance possible to score into the middle of the goal is approximately $\boxed{35.78}$.

*Because we do not have the game and field objects, we used the field measurements from online. Continued to page 1-27

SIGNATURE

DATE

5/5/15

DISCLOSED TO AND UNDERSTOOD BY

DATE

5/5/15

PROPRIETARY INFORMATION

VEX Nothing But Net: Objective and Obstacles (cont.)

5/5/15

- Next Time
 - Rank Goals by Importance
 - Discuss "Last Resorts"

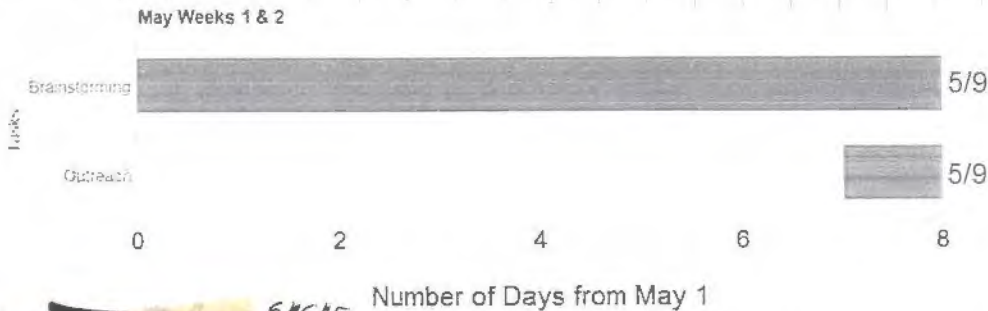

~~5/5/15~~ rest of the week

- For the ~~next two weeks~~^{1.1.}, we will continue brainstorming ideas.

~~5/5/15~~

Continued to page

SIGNATURE ~~_____~~

DATE 5/5/15

DISCLOSED TO AND UNDERSTOOD BY ~~_____~~
Ai

DATE 5/5/15

PROPRIETARY INFORMATION

Goal Prioritization

5/7/15

- Objectives for Today:
 - Rank Goals by Importance
 - Discuss "Last Resorts"
- To see what kind of scoring would get the most points, we decided to determine the maximum of points possible from the game.
- * Theoretically, the highest score possible is 630; however, this is assuming that^{AA} all of the balls and bonus balls will fit in the net, and that the opposing alliance placed their prebads on the field and the driver control loads as well.
- * Because the bonus balls and balls have the same diameter, density, ~~the~~^{AA} and exterior, they should use the same scoring mechanism. However, they are listed as separate entities in case they have different amounts of firmness on the outside or other discrepancies.
- To achieve the maximum amount of points, an alliance must:
 - 1) Score all of the balls in the high goal (470 points, 75% of score).
 - 2) Score all of the bonus balls in the high goal (100 points, 16% of score).
 - 3) Be at high elevation at the end of the match (50 points, 8% of score).
 - 4) Win autonomous (10 points, 2% of score).
- After calculating the percentages for each task, it was determined that shooting balls would get us closest to 630 points. Furthermore, if the balls and bonus balls are identical in texture, we could theoretically score 91% of the maximum score! Creating a high goal shooter will be our first priority, then elevation will be the second. Although autonomous victories only add 10 points to the total score, we will devote as much time as possible for autonomous testing, because we could use those 15 seconds to score points that will count at the end of the match.

Continued to page 1-29

SIGNATURE

DATE

5/7/15

DISCLOSED TO AND UNDERSTOOD BY

DATE

5/7/15

PROPRIETARY INFORMATION

Last Resorts

5/7/15

- Last Resorts
- In the event that the robot cannot perform the 4 tasks listed on pg. 1-28, we discussed other options. The flow chart below displays our general plan in a match.

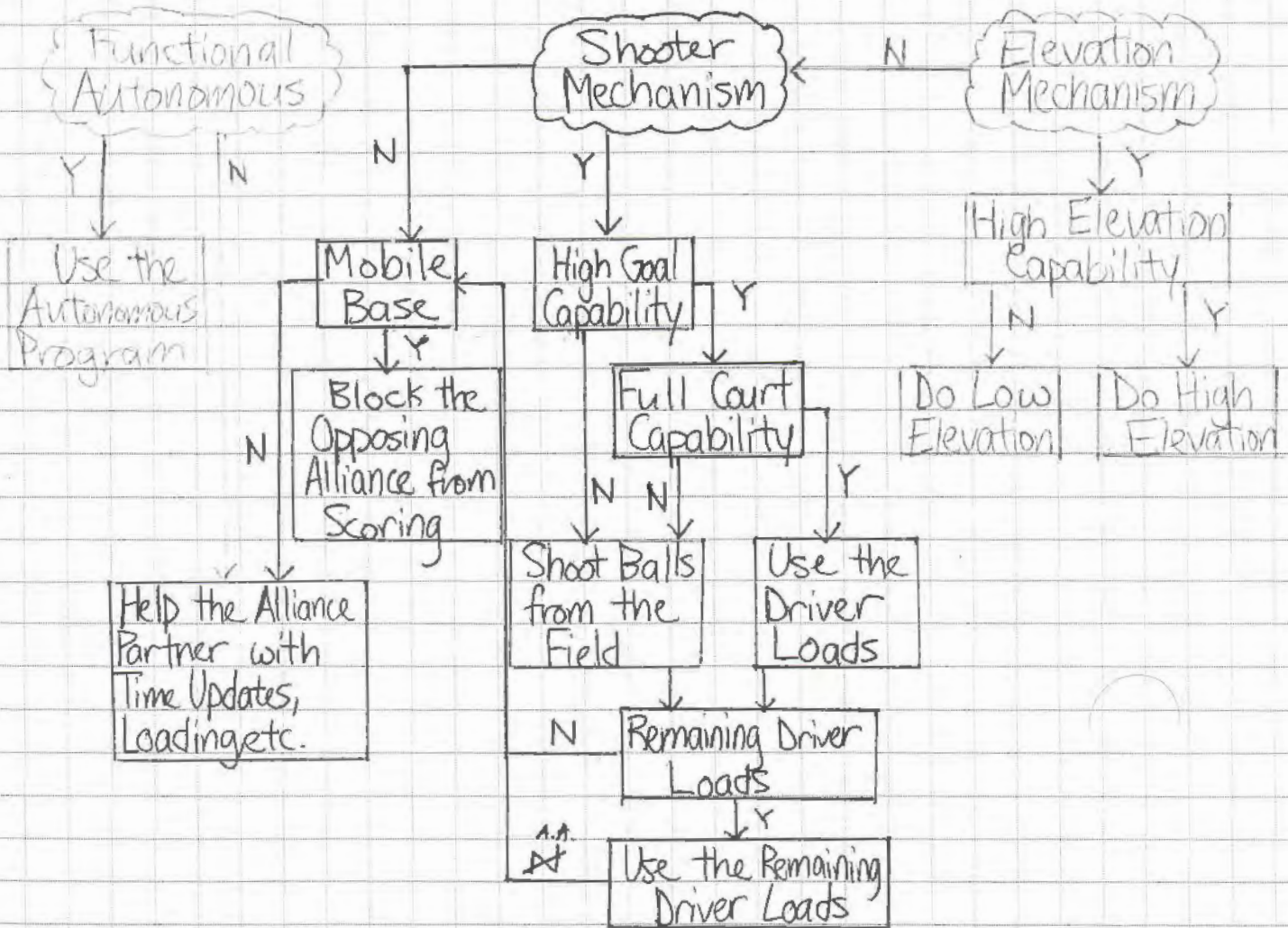

Key

- ☁ Starting Area
- ▭ Actions/Robot Characteristics
- Y Yes
- N No
- Autonomous Period Tasks
- Driver Control Period (0:00-1:15) Tasks
- Driver Control Period (1:15-1:45) Tasks

Continued to page 1-30

SIGNATURE

DATE

5/7/15

DISCLOSED TO AND UNDERSTOOD BY

DATE

5/7/15

PROPRIETARY INFORMATION

Last Resorts (cont.)

5/7/15

* While discussing last resorts, we also created strategies. Since we have already brainstormed field strategies, we will brainstorm designs next meeting.

- Next Time
- Brainstorm Robot Designs

5/7/15

Continued to page

SIGNATURE

DATE

5/7/15

DISCLOSED TO AND UNDERSTOOD BY

DATE

5/7/15

PROPRIETARY INFORMATION

Design Brainstorm

5/12/15

- Objectives for Today:
 - Brainstorm Robot Designs
- Today we all drew a rough sketch of a robot. We then explained why we chose this design to the other members.
- The most prominent idea was the wheel shooter. With this design, the ball would be placed between two wheels, which would be turning at high speed. Having two wheels on each side would balance the ball's direction, creating better accuracy. Furthermore, the grip from the wheels' exterior would assist in having a faster outtake.
- Possible Variations
 - Low-Strength Gears vs. High-Strength Gears: Low-strength gears would have less friction, which would possibly assist with high speed gearing. However, high-strength gears are more durable.
 - Number of Wheels: Two wheels on either side would be ideal, but the ball may curve to one side. We may need to add more wheels above or below the launching one for more stability.
 - Wheel Type: The larger the wheel is, the higher the circumference. This means with one revolution, the larger wheels will cover more distance, giving more pushing power to the ball. Additionally, the different bumps and ridges on the outside of the wheel will provide different amounts of grip. The more grip the wheels have, the farther the balls will shoot.
 - Gear Ratio: In order to shoot the balls at least 3 feet (the shortest distance to the high goal), we will undoubtedly need to gear the wheel shooter for speed. However, having too high of a speed ratio will consume too much power and stall the motors, and having too low of a ratio will not allow us to reach ~~the~~^{the} high goal. We predict that the ratio will fall between 9:1 or 49:1. We will start from the lower ratios first, because they will consume

SIGNATURE

DATE

5/12/15

DISCLOSED TO AND UNDERSTOOD BY

DATE

5/12/15

PROPRIETARY INFORMATION

Continued to page 1-32

Design Brainstorm (cont.)

5/12/15

- less power.
- There was also a catapult idea, where a launcher would be tensioned down, then fling the ball.
 - Possible Variations
 - Tensioning System: we could use a system where the launcher is tensioned down with rubber bands or surgical tubing or we could have the front part of the catapult be hit by something that drops down quickly.
 - For intaking the balls, we could create a conveyor belt with flaps that could give more grip on the balls.
 - Possible Variations
 - Gear Ratio: The conveyor belt could be geared for speed to generate momentum for the shooter.
 - Funnel: We may add a funnel system at the bottom of the robot so that one would need less accuracy to intake a ball.
 - Next Time
 - Brainstorm Robot Designs

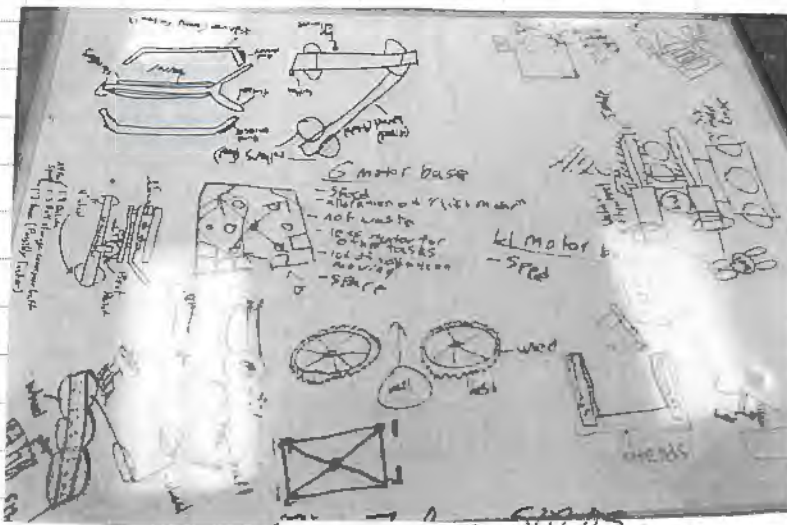

These are the various ideas from the design brainstorm. We started to discuss base designs, but were unable to finish. We will continue this discussion for tomorrow.

SIGNATURE

Continued to page 1-33

DATE

5/12/15

DISCLOSED TO AND UNDERSTOOD BY

DATE

5/12/15

PROPRIETARY INFORMATION

Design Brainstorm (cont.)

5/12/15

• Design Close-Ups

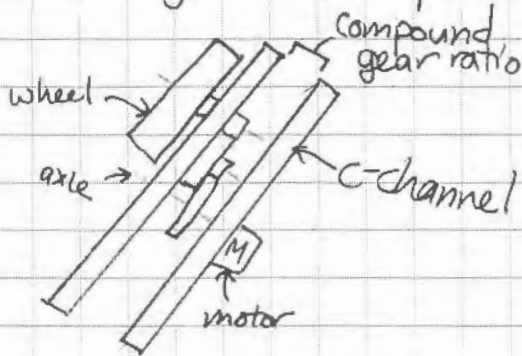

• Wheel Shooter

- The number of wheels and the number of teeth on the gears may vary, but every shooter will have this general design.

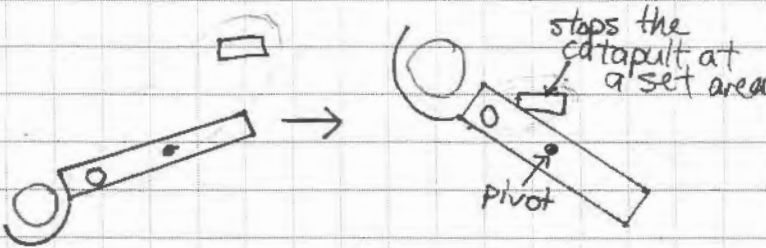

• Catapult

- The way to attach the launcher to the tensioning system may be different, but the design will generally be the same.

- Metal Key - Rubber Bands - Ball

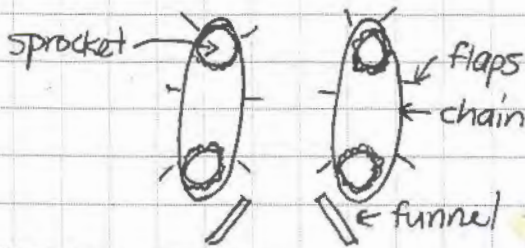

• Conveyor Belt

- The addition of the funnel may vary.

May Week 3

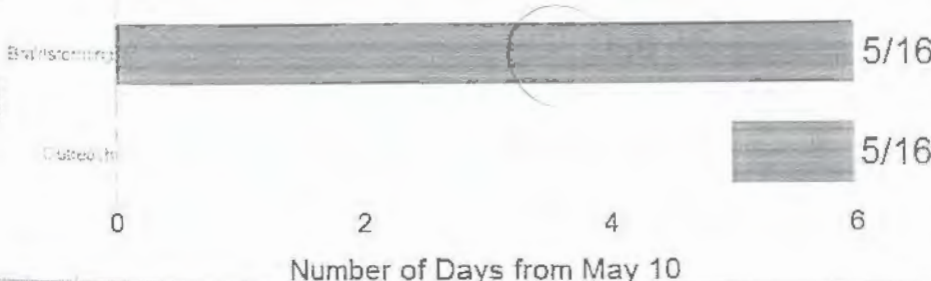

- We will continue brainstorming ideas for the rest of the week.

SIGNATURE _____

DATE 5/12/15

DISCLOSED TO AND UNDERSTOOD BY _____

DATE 5/12/15

PROPRIETARY INFORMATION

Design Brainstorm Day 2

5/14/15

- Objective for Today
 - Brainstorm Robot Designs
- We continued our base design discussion ~~with~~^{AA} from last meeting.
- As shown on pg. 1-32, we discussed the possibility of a 6-motor base. Because VEX Nothing But Net is an offensive game where robots will push each other to get to the shooting area, our robot will need a powerful base. However, this reduces the number of motors we could use for balls and elevation, and it will use up more voltage. Our decision will heavily depend on how compatible the designs will be with the ball and elevation mechanism.
- With the offensive nature of the game (as mentioned in the previous paragraph), another question arose: how can we prevent other robots from pushing our robot?
 - One idea was to ~~use~~^{not} use an all omni-wheel base. Because omni-wheels have small wheels around its exterior, it would take next to no effort to push an all omni-wheel base sideways.
 - Another idea was to have a pneumatic brake. When activated, the piston would plant a c-channel firmly on the ground, preventing movement from any direction.
 - Although a base's primary function is to move around the field, it may also have the ability to earn points. One member introduced the idea of a "scissor base", where a robot would be able to lift itself over its alliance partner, using a scissor lift. A picture is shown on the following page.
- Next Time
 - General Prototype Designs
- * Because the members have already chosen what general design they will build, we will not have a third day for brainstorming.

Continued to page 1-35

SIGNATURE

DATE

5/14/15

DISCLOSED TO AND UNDERSTOOD BY

DATE

5/12/15

PROPRIETARY INFORMATION

Scissor Base Concept

5/14/15

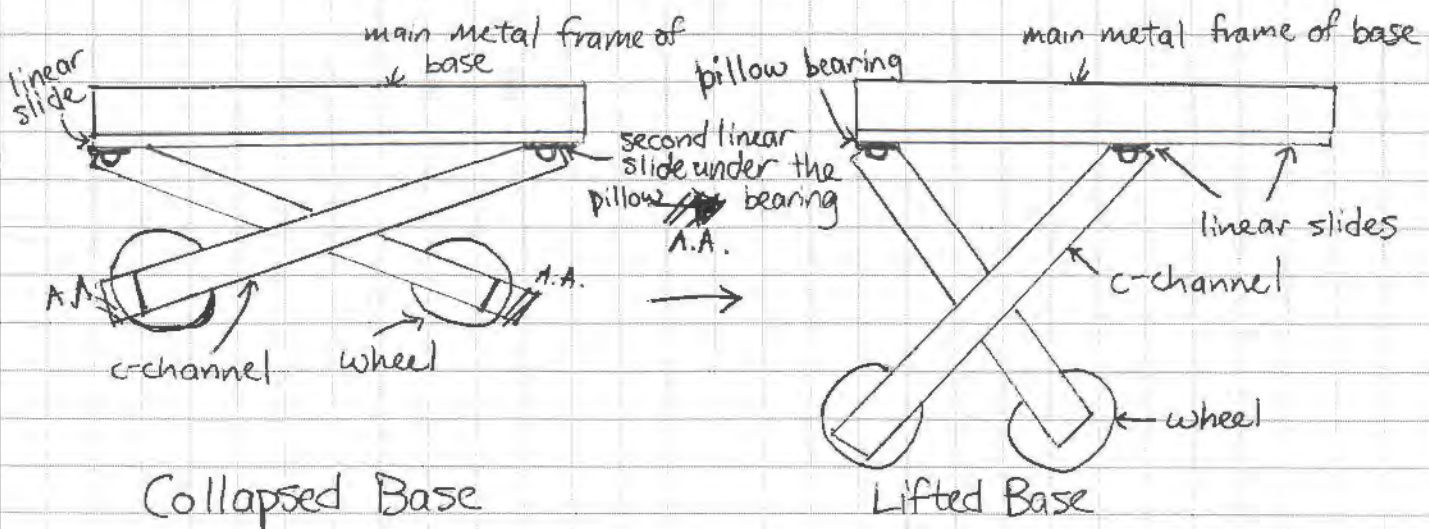

Collapsed Base

Lifted Base

- With the collapsed base, the robot can move around the field normally. Then, in the final 30 seconds, the robot lifts up so that the linear slides and the main frame of the base are above the alliance partner's robot.
- Possible Variations
 - Source of Power: Since the elevation portion of the game only occurs once, using pneumatics would be feasible. However, we also have the option of using motors, the way scissor lifts are usually powered.
 - Additional Mechanisms: Depending on whether the robot attaches itself or ~~it~~^{A.A.} expands horizontally past 18", the robot will have to drive on the field. Driving on the field may cause the robot to tip over, because the robot's center~~ee~~^{A.A.} of gravity shifted. However attaching to the ~~robot~~^{A.A.} other robot may cause the other robot to tip over instead. If we are able to expand horizontally and drive with the lift activated, our robot would have more stability stacked on the other robot, compared to hanging off of the side of the robot while attached.

Continued to page

SIGNATURE

DATE

5/14/15

DISCLOSED TO AND UNDERSTOOD BY

DATE

5/14/15

PROPRIETARY INFORMATION

General Prototype Designs

5/19/15

- Objective for Today
- General Prototype Designs

- Today, we started our meeting by making more detailed sketches of our designs. We did this so that different groups would not build the same thing. We split into 2 groups (which will be referred to as Group 1 and Group 2).
- Group 1's Design

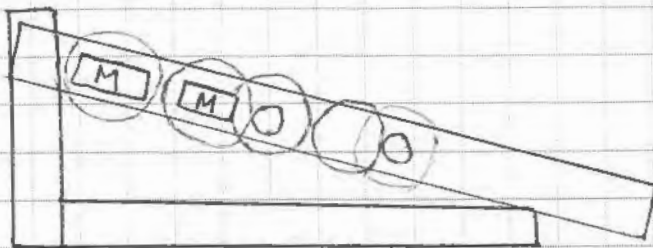

Side View

Key	
—	Metal
M	Motor
—	60-tooth Gear
—	Pinion
—	Wheel

$$\frac{30 \cdot 30}{20 \cdot 12} = 1.5$$

$$= \boxed{5:1}$$

$$\frac{60 \cdot 60}{60 \cdot 12} = 1.5$$

$$= \boxed{5:1}$$

$$5 \cdot 5 = \boxed{25:1}$$

Ratio

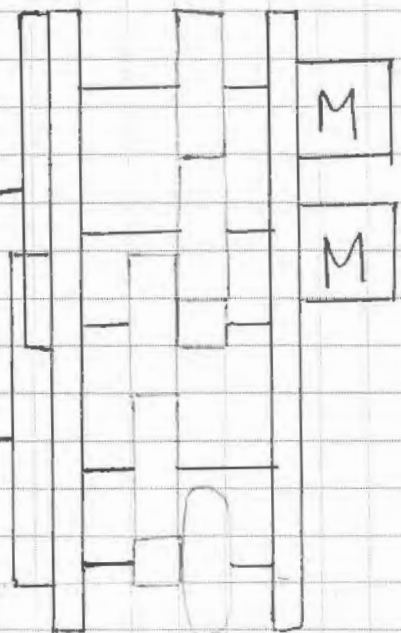

Gear Ratio Close-Up

- This design is a 25:1 wheel shooter powered by 2 motors. Because we are only testing shooter mechanisms, we ~~are~~ will create a mount so that we can load the shooter with ease. A 2.75" High Traction Wheel was used so there would be more grip on the ball. The topmost idler gear was included so that both motors would turn at the same rate (shown in the ratio close-up). The bottommost idler gear (also shown in the ratio close-up) was included to prevent the wheel from making contact with the pinion.

Continued to page 1-37

SIGNATURE

DATE

5/19/15

DISCLOSED TO AND UNDERSTOOD BY

DATE

5/19/15

PROPRIETARY INFORMATION

General Prototype Designs (cont.)

5/19/15

Group 2's Design

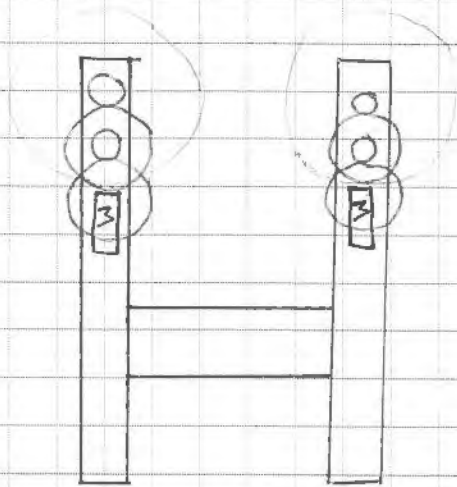

Top View

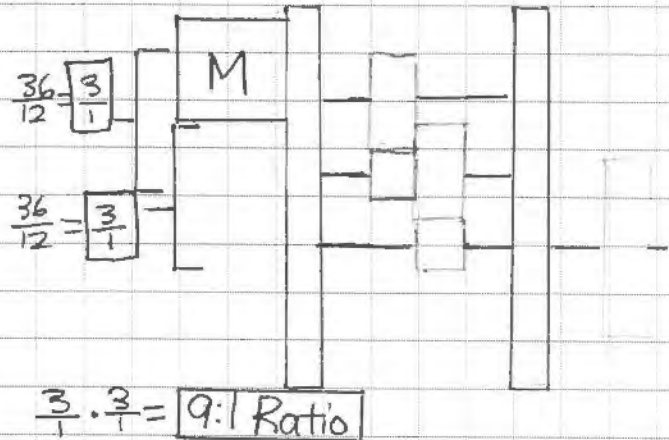

Gear Ratio Close-Up

Key				
— Metal	M Motor	— 36-tooth Gear	— Pinion	— Wheel

- This design is a 9:1 wheel shooter powered by 2 motors, with one on each side. We will use 2 5" wheels, because they will give more pushing power. These wheels also have a bumpy exterior, which will provide more grip on the ball.

- Next Time
- Build Design

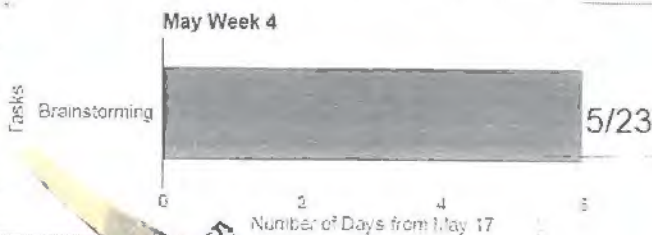

- We have already finished the brainstorming phase, which means we are ahead of schedule.

Continued to page

SIGNATURE

DATE

5/19/15

DISCLOSED TO ANY ONE

DATE

5/19/15

PROPRIETARY INFORMATION

General Prototyping Day 2

5/2/15

- Objective for Today
 - Build General Prototype Designs (on pg. 1-36 and 1-37)
- Group 1 Design 1 (on pg. 1-39)
 - Today we were able to finish the 25:1 wheel shooter. We added a truss on the side of the shooter for more support. However, when we tested it once, ^{the ball} ~~it~~ went up a few feet, then the motors died. We believe this ^{occurred} ~~was~~ because the wheel or gear ratio was too small. Consequently, we will use a bigger gear ratio and a bigger wheel. We will also add rubber bands around the wheel for grip. To prevent the motors from dying, we will add one additional motor for a total of 3 motors on the shooter. A diagram is shown below.
- ~~Group 1 Design 2~~

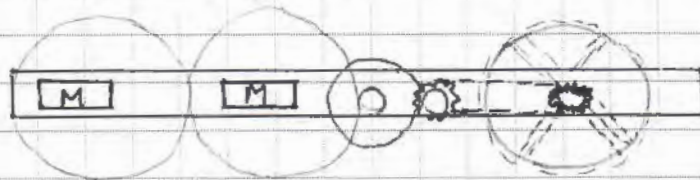

Side View

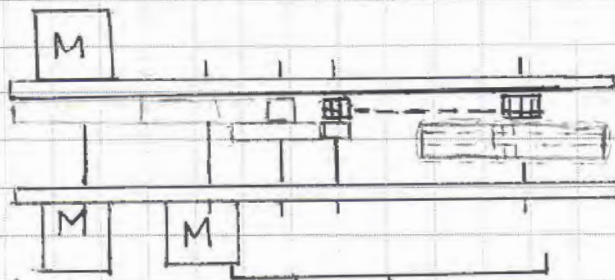

$$\frac{84}{84} \cdot \frac{84}{12} = 7 \quad \frac{60}{12} = 5 \quad 7 \cdot 5 = 35:1 \text{ Ratio}$$

Gear and Sprocket Ratio Close-Up

- This is a 35:1 wheel shooter powered by 3 motors. An idler gear was included to ensure all of the motors would turn at the same rate. A sprocket-and-chain system was used to transfer the speed ratio to the 5" wheel and to prevent the wheel from making contact with the gear train.

Continued to page 1-39

SIGNATURE

DATE

5/2/15

DISCLOSED TO AND UNDERSTOOD BY

DATE

5/2/15

PROPRIETARY INFORMATION

General Prototyping Day 2 (cont.)

5/21/15

- Group 2 Design 1 (on 1-37)
- We completed both sides of the shooter and mounted them on a c-channel. We then realized that the wheels were spaced too far apart. Unfortunately, we were unable to move in the ~~the~~ c-channels today, so we will find the correct spacing and test it next meeting.
- Next Time
 - Build Group 1 Design 2
 - Finish Group 2's Design
 - Test Group 2's Design



Everyone is working hard on the prototypes!

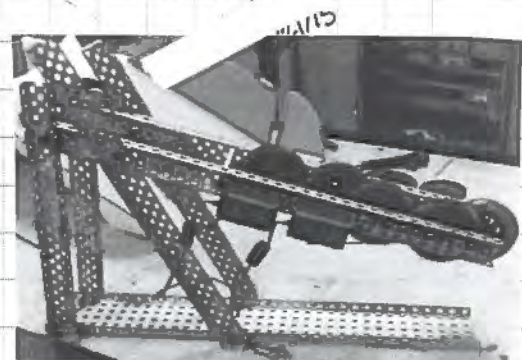

Group 1 Design 1 (25:1 Wheel Shooter)

* Because we do not have VEX Nothing But Net Balls or Bonus Balls, we are using a replacement ball with a similar size and density.

5/21/15

SIGNATURE
[Redacted Signature]

DATE
5/21/15

Continued to page

DISCLOSED TO AND UNDERSTOOD BY
A.

DATE
5/12/15

PROPRIETARY INFORMATION

~~CADD Day~~ AA

July Schedule

7/1/15

[Redacted] - 7/1/15

July 2015

Sun	Mon	Tue	Wed	Thu	Fri	Sat
			1 CADD Designs Robotics Summer Camp Mentoring	2 Robotics Summer Camp Mentoring	3	4 Independence Day
5	6 Robotics Summer Camp Mentoring	7 Robotics Summer Camp Mentoring	8 CADD Designs Robotics Summer Camp Mentoring	9 Robotics Summer Camp Mentoring	10	11
12	13 Robotics Summer Camp Mentoring	14 Robotics Summer Camp Mentoring	15 CADD Designs Build Scissor Base Robotics Summer Camp Mentoring	16 Robotics Summer Camp Mentoring	17	18
19	20 Robotics Summer Camp Mentoring	21 Robotics Summer Camp Mentoring	22 CADD Designs Robotics Summer Camp Mentoring	23 Robotics Summer Camp Mentoring	24	25
26	27 Robotics Summer Camp Mentoring	28	29 CADD Designs	30	31	

July Schedule

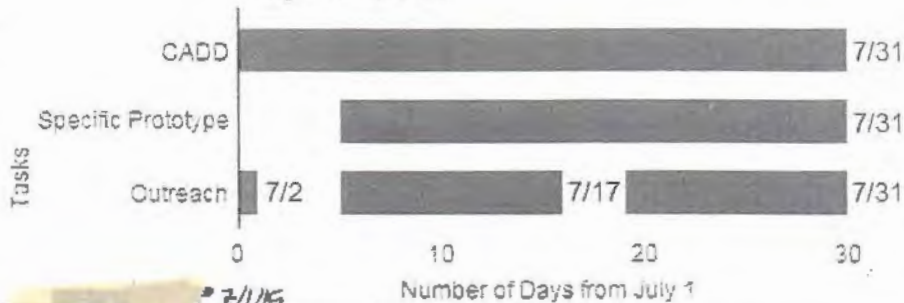

Throughout the month, we will CADD and prototype ideas.

Continued to page

SIGNATURE [Redacted]

DATE 7/1/15

DISCLOSED TO AND UNDERSTOOD BY

[Signature]

DATE 7/1/15

PROPRIETARY INFORMATION

CADD Day 4

7/1/15

- Objective for Today
- CADD Designs

2-Wheel Shooter

Today, we completed CADing the 2-wheel shooter. Unlike the shooters we built during the General Prototype phase (on pg. 1-37 to 1-45), this design has a 21:1 gear ratio.

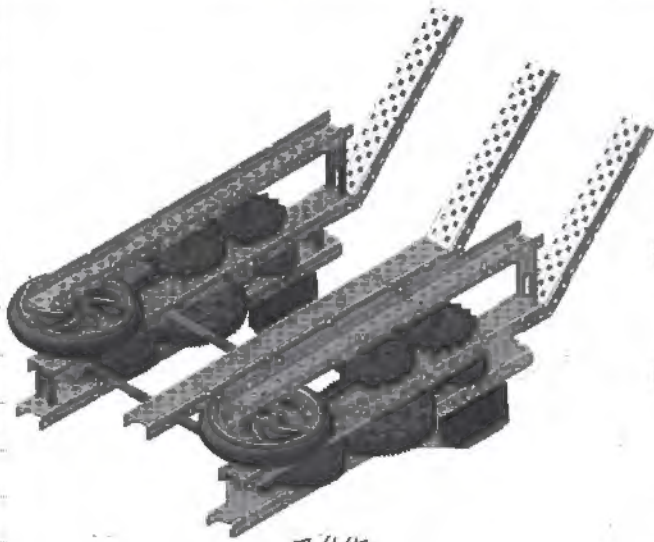

7/1/15

Isometric View (Left)

7/1/15

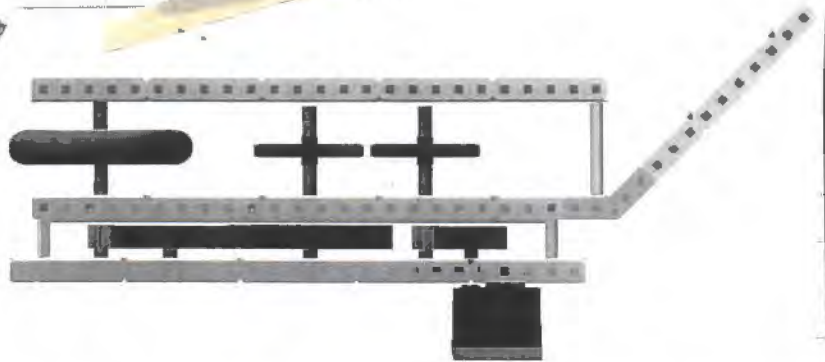

Gear Ratio Close-Up (Above)

$$\frac{36}{12} \cdot \frac{84}{60} \cdot \frac{60}{12} = 3 \cdot \frac{7}{5} \cdot \frac{5}{1} = 21:1 \text{ Gear Ratio}$$

The space between the wheels is 3.778", and the balls are 4" so $4 - 3.778 = 0.222"$ are being compressed. This means that the ball would have $\frac{0.222}{4} = 55\% \text{ Compression}$.

- Next Time
- CADD Designs

July Weeks 1 & 2

7/1/15

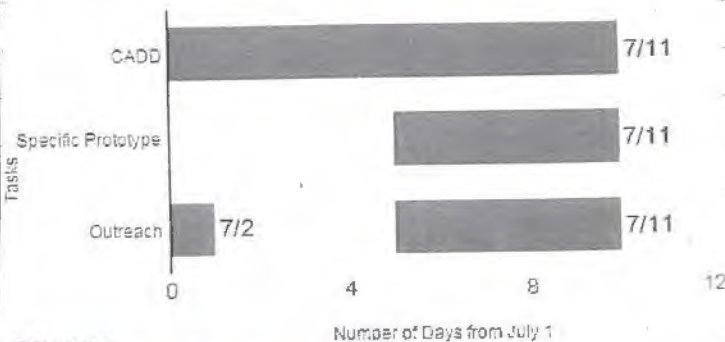

We will continue CADing for the rest of the week.

Continued to page

SIGNATURE

Number of Days from July 1

DATE

7/1/15

DISCLOSED TO AND UNDERSTOOD BY

Ai

DATE

7/1/15

PROPRIETARY INFORMATION

CADD Day 5

7/8/15

- Objective for Today
- CADD Designs

- Linear Slide Concept

- For the linear slide concept, the robot will have 2 slides on each side of the robot. The slides will be attached to a fork lift that will lift up the robot for high elevation. The slides will be powered by 1 pinion on each. ~~The ^{pin}~~ We chose to use the pinions, because its strong, metal composition will be able to withstand the weight of another robot. However, the unbalanced center of gravity may cause the robot to tip over.



Linear Slide
Isometric View

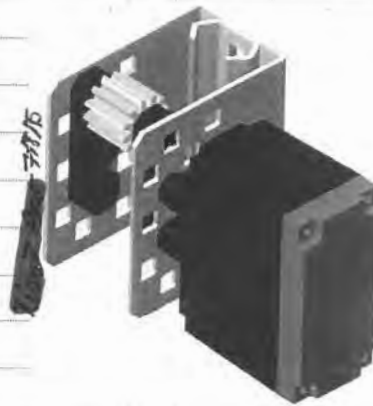

Mount for
Motor (Isometric
View)

- Next Time
- CADD Designs
- Build Scissor Base

7/8/15

Continued to page

SIGNATURE

DATE

7/8/15

DISCLOSED TO AND UNDERSTOOD BY

DATE

7/8/15

PROPRIETARY INFORMATION

CADD Day 6/Specific Prototype Day 1

7/15/15

- Objectives for Today
 - CADD Designs
 - Build Scissor Base
- To start, we CADDed the scissor base (on pg. 1-35) so that we can build it with ease and save the design if we want to use it during the building phase.

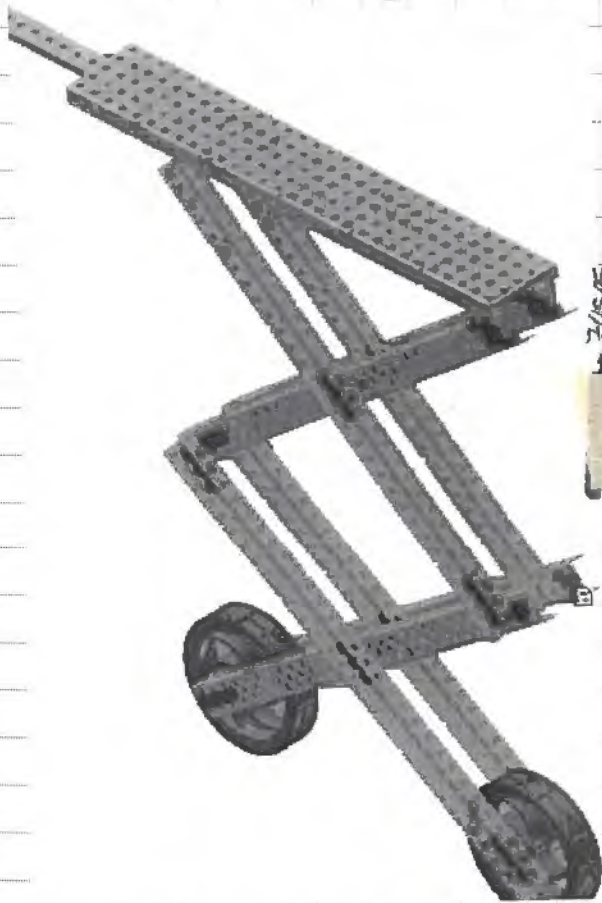

Isometric View

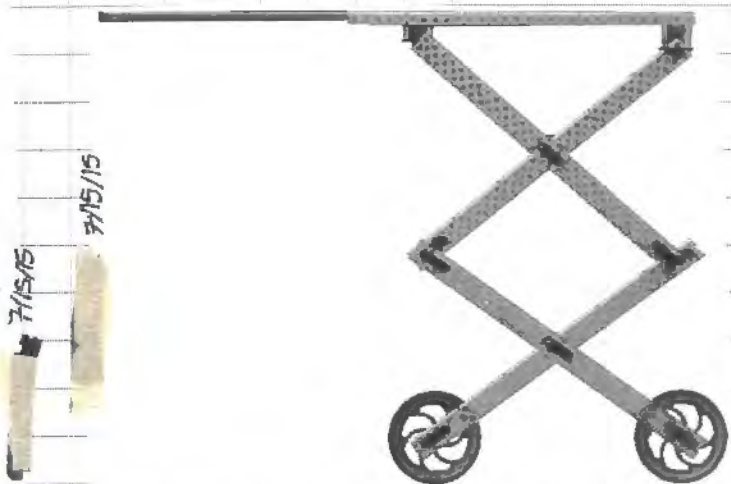

Front View

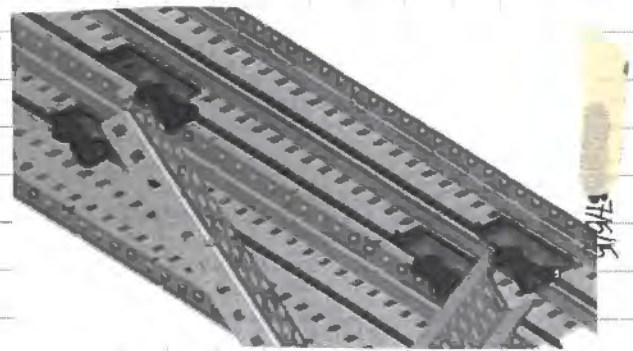

Slide Close-Up

- At first, we wanted to build a 1-stage scissor base. However, we realized that it would be more advantageous to build 2 stages, because it would only need to rotate/activate its powering system halfway to reach the same ^{AA} distance of height that the

Continued to page 1-62

SIGNATURE

DATE

7/15/15

DISCLOSED TO AND UNDERSTOOD BY

DATE

7/15/15

PROPRIETARY INFORMATION

CADD Day 6/Specific Prototype Day 1 (cont.)

7/15/15

1-stage base would reach ^{with A.A.} fully rotated/activated motors or pistons. Furthermore, having a wider base would improve the robot's stability.

- Next, we started to construct the scissor base. Although we CADDed a 2-stage base (on pg. 1-61), we built a 1-stage base to test the concept first. Unfortunately, we do not have pneumatics or motors to test the base, so we must wait until the flex phase to test.



Scissor Base Side View

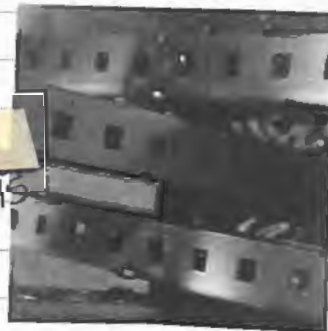

Scissor Base Spacing

- Next Time
-CADD Designs

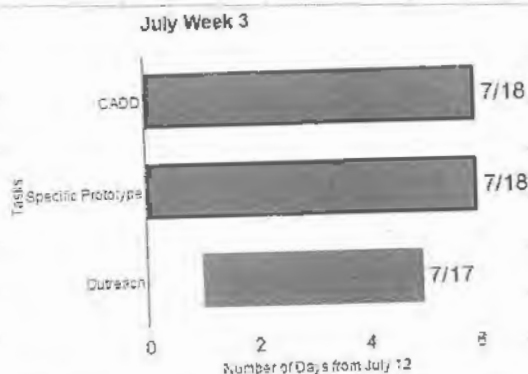

- We will continue CADDing and specific prototyping for the rest of the week.

Continued to page

SIGNATURE

DATE

7/15/15

DISCLOSED TO AND UNDERSTOOD BY

DATE

7/15/15

PROPRIETARY INFORMATION

Summer Camp Research

7/16/15

- At the summer camp, the camp counselors built a robot to help the students draw inspiration from its design (For more information about the summer camp, see the outreach section in the binder). Consequently, we were permitted to prototype designs to assist the students with their robots.
- * Although the 1575A members constructed parts of the robot, other volunteers and mentors also contributed to its construction. Because 1575A does not hold complete ownership to the designs, they cannot be included as part of our specific prototype phase.
- * Mentors [redacted] and [redacted] were also contributors to the camp robot's construction.
- Camp Robot's Design
 - The base was powered by 4 motors and had 4 4" omni-wheels. A U-base was chosen to encompass a wheel shooter. A 21:1 gear ratio was used on the shooter, powered by 4 motors. Instead of having one wheel contact on each side (see pg. 1-52 and 1-54 for examples), the robot had a stack of 4 wheels to compress the ball on one side. The robot also had a curved ramp to change the trajectory of the ball. A 3:1 gear ratio intake gathered the balls with a "conveyor belt".
- Observations
 - The robot was able to shoot into the high goal from 15 feet away; however, when continuously shooting balls without pausing, the shooting height decreased by approximately 1 foot per ball. Depending on the angle of the curved plate, the balls' trajectories would change. The steeper the ramp, the higher the balls^{A.A.} would reach. The flatter the ramp, the further the balls would reach. We found that the optimal angle was 45° . This is because a 0° ramp would be the flattest ramp possible, while a 90° ramp would be the most vertical ramp possible. When one averages the two ($\frac{0+90}{2} = \frac{90}{2}$), the resulting number is 45° .

Continued to page 1-64

SIGNATURE

DATE

DISCLOSED TO AND UNDERSTOOD BY

DATE

PROPRIETARY INFORMATION

Summer Camp Research (cont.)

7/16/15

- Planetary Gear
- Mentor [redacted] explained a gearing system known as a planetary gear. It allows the ratio on a mechanism to switch between torque and speed and switch directions.
- Observations
 - The gearing system functioned well; however, the design is incompatible with this year's game. Having one planetary gear on each side for the base would significantly limit the amount of space for our shooting and elevation mechanisms. Furthermore, the shooting mechanism would always have to be fast to shoot the ball high and far, so a torque ratio would be extraneous. gear ratio with higher torque would be extraneous. Furthermore, it would be inefficient to have our drivers (who have little driving experience) have to toggle direction and ratio. Having a normal gearing system would allow the drivers to become accustomed to the controls quickly, and score more.

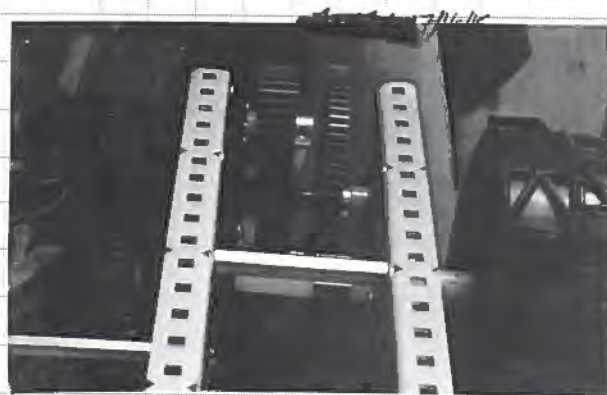

Gear Ratio Close-Up

Notice the base's structure and the stack of wheels being placed on the robot. Compressing the ball on one side with 4 wheels allow the ball to be compressed evenly.

Continued to page | -65

SIGNATURE

DATE

7/16/15

DISCLOSED TO AND UNDERSTOOD BY

DATE

7/16/15

PROPRIETARY INFORMATION

Summer Camp Research (cont.)

7/16/15

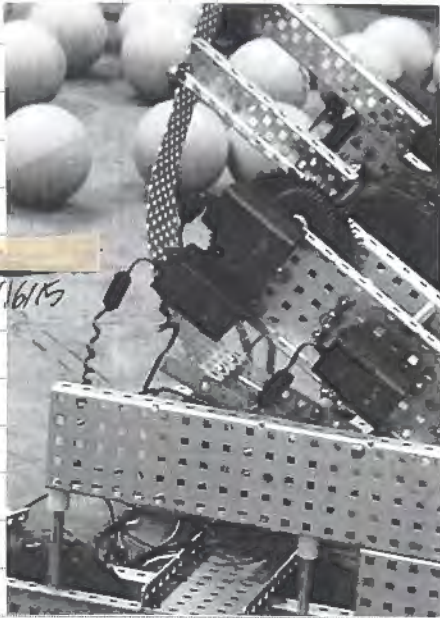

7/16/15

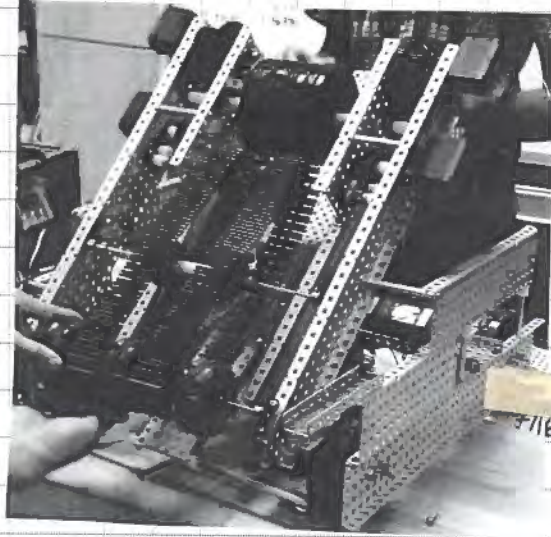

7/16/15

Camp Robot

Curved Plate
Close-Up



7/16/15

7/16/15

Planetary Gear

Continued to page

SIGNATURE

DATE

7/16/15

DISCLOSED TO AND UNDERSTOOD BY

DATE

7/16/15

PROPRIETARY INFORMATION

A.C.

CADD Day 7

7/22/15

- Objective for Today
- CADD Designs

- Today, we CADDed possible gear designs for the robot.
- Planetary Gear (on pg. 1-64 and 1-65)
- As explained on the pages listed above, the planetary gear can switch directions and gear ratios. Although we explained that this gearing system may not be compatible with this year's game, we CADDed it in case we decide to use it in the building phase.

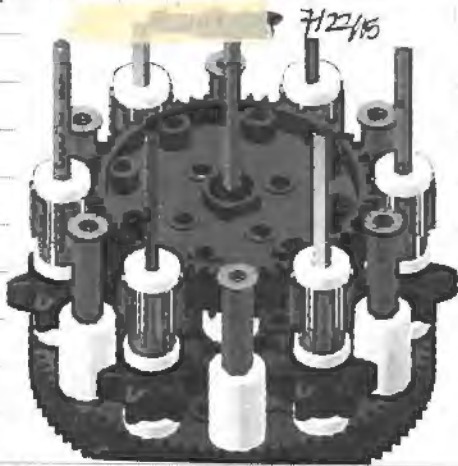

Isometric View (without Top Gear)

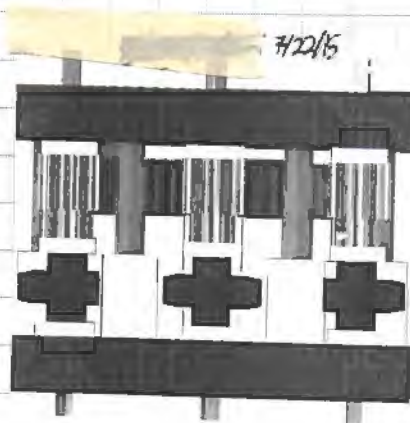

Front View (with Top Gear)

- The top gear was removed to give a clear view of the inside.

• Nautilus Gear

- While browsing the parts on the VEX Robotics website (www.vexrobotics.com), we discovered the part known as a cam. The cam would rotate and push out the follower until it reaches its widest point. Then, the cam returns to its thinnest point and the follower collapses again. The cam-and-follower mechanism could be used for the elastic designs (on pg. 1-44, 1-45, 1-48, and 1-50). We could pull back

Continued to page 1-67

SIGNATURE

DATE

7/22/15

DISCLOSED TO AND UNDERSTOOD BY

DATE

7/22/15

PROPRIETARY INFORMATION

CADD Day 7 (cont.)7/22/15

the launchers, then release them and rewind. Furthermore, having an exact starting and ending width will allow the elastic launchers to retract to the same position consistently. We decided to CAD our own cam, because we can freely change the dimensions of the cam to make it compatible with our robot's design.



Custom-Made Cam (Isometric View)
Based on the dimensions from this CAD, we will cut out a cam from a sheet of plastic.

- Next Time
- CAD Designs

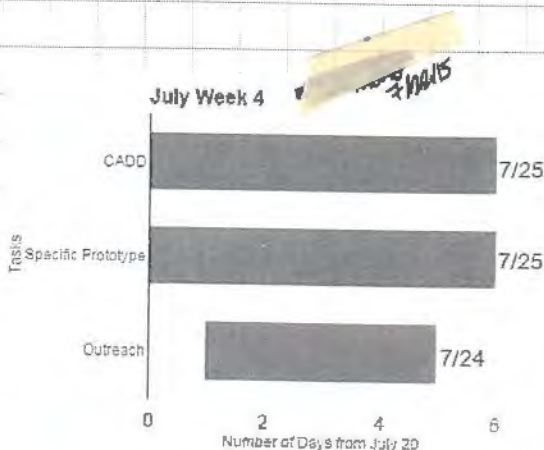

- We will continue CADDing for the rest of the week.

SIGN

Continued to page

DATE

7/22/15

DISCLOSED TO AND UNDERSTOOD BY

DATE

7/22/15

PROPRIETARY INFORMATION

Summer Camp Research 2

7/23/15

- At the next summer robotics camp we mentored at, we also built designs as examples for the students (For more information about the camps see the outreach section in the binder).
- * Because mentors and volunteers not affiliated with 1575A also contributed to the following designs, 1575A does not hold complete ownership of these designs. As a result, the designs will be recorded as research, not specific prototyping.
- * Mentors [redacted] and [redacted] also contributed to the designs' construction.
- Camp 'Robot's Design (on pg. 1-63)
- * The camp robot's design is the same as the previous design (shown on the above page), except for the adjustments listed below.
 - Instead of the stacked wheels, the robot had 2 5" wheels (1 on each side), similar to the design on pg. 1-42^{AA} and 1-59. However, the wheels were stripped of their rubber exterior, leaving a hard, plastic rim. The wheels are powered by a 35:1 gear ratio for speed.
- Observations
 - With the above adjustments, the robot could shoot past the high goal from the furthest distance possible. However, the motor's quickly burned out, so the ratio was changed back to 21:1 for speed. After this adjustment, the shooter could shoot into the high goal from the furthest distance possible on 50% power. Along with the results from the general prototype phase, this data also supports our prediction that wheel size and wheel exterior would affect the shooting distance (shown under "Wheel Type" on pg. 1-31).
- Kicking Wheel Design
 - For this design, only the shooting mechanism was built.
 - The design consisted of a 30⁺ tooth sprocket, fully surrounded by chain. A chain link that standoffs

SIGNATURE

DATE

DISCLOSED TO AND UNDERSTOOD BY

DATE

PROPRIETARY INFORMATION

Continued to page 1-69

Summer Camp Research 2 (cont.)

7/23/15

could be attached to were placed on opposite sides of the sprocket. Two standoffs were attached to each link. The sprocket was powered by 35:1 gear ratio for speed. When the ball was rolled down a ramp, one pair of standoffs would "kick" it into the air.

• Observations

- The kicking wheel could shoot approximately 8' away from the high goal into the high goal. Putting more than 2 evenly spaced links with standoffs caused the standoffs to hit the ball, but not kick it. This was because there was not enough space for the ball to make contact with the wheel.

• Fan Design

- The fan design had a 25:1 ratio. The speed ratio was very high, because the fan had to change the trajectory of a ball by blowing air on it.

• Observations

- The fan design did not function, because the fan's blades were going too slow, and increasing the ratio would cause the motor to burn out. This design will most likely not be used in the building phase.

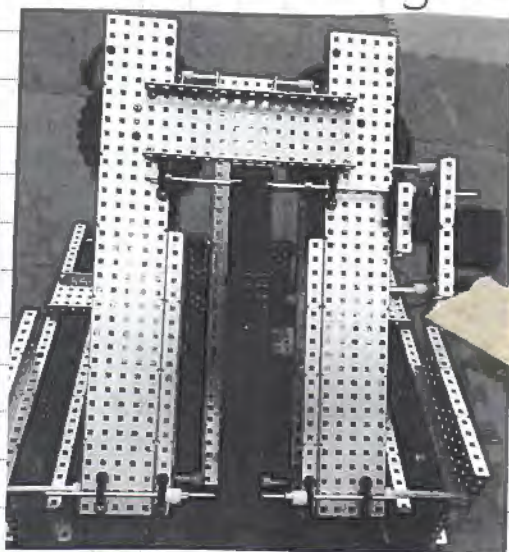

Camp Robot

Continued to page 1-76

SIGNATURE

DATE

7/23/15

DISCLOSED TO AND UNDERSTOOD BY

DATE

7/23/15

PROPRIETARY INFORMATION

Summer Camp Research 2 (cont.)

7/23/15

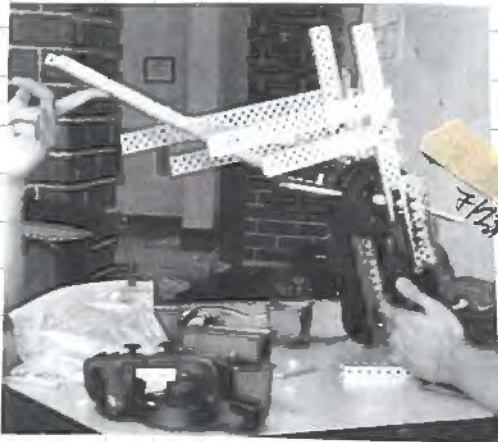

Kicking Wheel Design

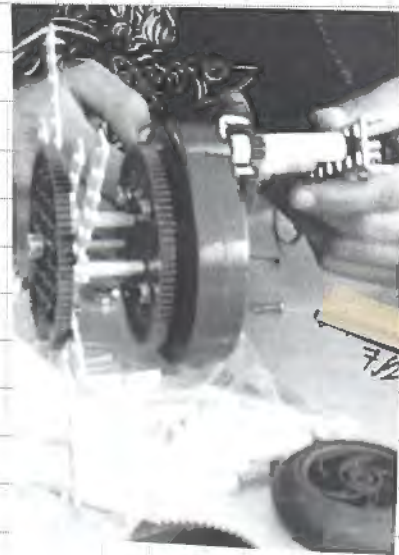

Fan Design



Continued to page

SIGNATURE

[Redacted signature]

DATE

7/23/15

DISCLOSED TO AND UNDERSTOOD BY

hr

DATE

7/23/15

PROPRIETARY INFORMATION

September Schedule

9/1/15

September 2015

Sun	Mon	Tue	Wed	Thu	Fri	Sat
		1 Test Sensor Base	2 Brainstorming Design	3 Design Decisions	4	5
6	7	8 Build Base	9 Build Program Base	10 Build Program Base	11 Test Base	12
13	14 Test Base	15 Build Intake	16 Build Intake and Shooter	17 Build Shooter	18 Build Program Intake and Shooter	19
20	21 Test Intake and Shooter	22	23 Test Intake and Shooter	24	25 Test Intake and Shooter	26
27	28 Test Intake and Shooter	29 Test Intake and Shooter	30 Test Intake and Shooter Holy Family Catholic School Mentoring			

9/1/15

September Schedule

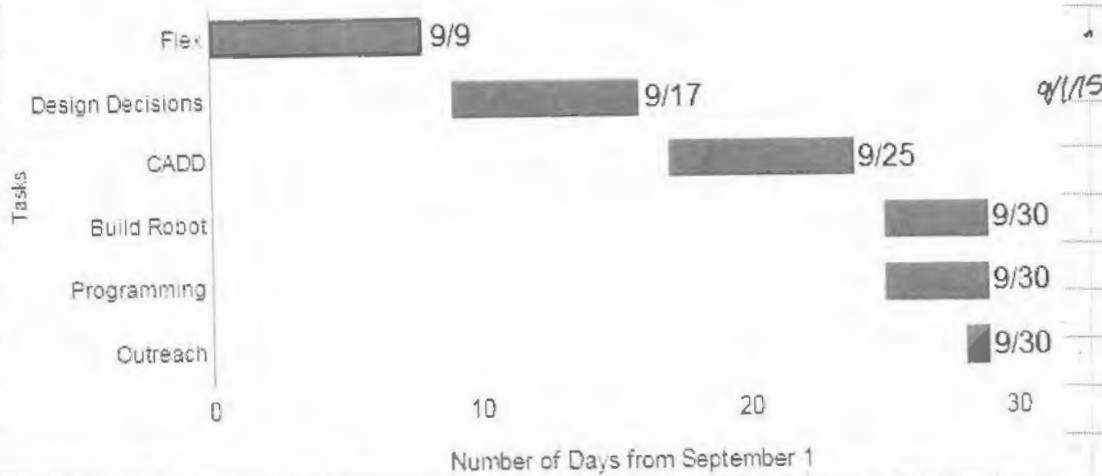

9/1/15

* Because our first tournament is scheduled for October 31st, we decided to quicken the Season Gantt Chart (on pg. 1-22) and move up the Design Decision, CADD, Build Robot, and Programming phases to have more time to refine our design.

Continued to page

SIGNATURE

[Redacted Signature]

DATE

9/1/15

DISCLOSED TO AND UNDERSTOOD BY

[Signature]

DATE

9/1/15

PROPRIETARY INFORMATION

Scissor Base Testing 9/1/15

- Objective for today:
 - Test scissor base

Scissor Base

- The design did not work as planned because the base was too heavy and the pneumatics were not strong enough.

Scissor Base Side View



9/1/15

Scissor Base Top View

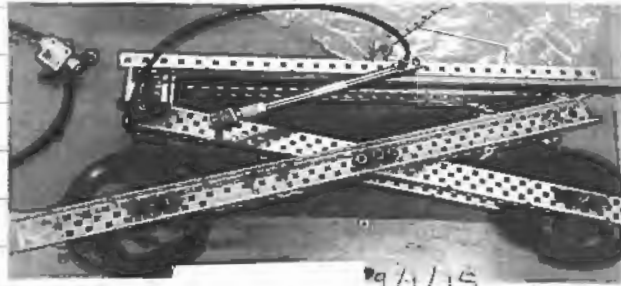

9/1/15

- Even with the maximum amount of air pressure (100 psi), the base could not lift. Because there was no c-channel connecting the two wheels on the sides, the base was too unstable.
- Next time, we will do brainstorming.

September Week 1



- We will test prototypes and brainstorm designs for the rest of the week. If there is enough time, we will decide what designs we will use for the robot.

Continued to page

SIGNATURE _____

DATE 9/1/15

DISCLOSED TO AND UNDERSTOOD BY *ht*

DATE 9/1/15

PROPRIETARY INFORMATION

Brainstorming 2

9/2/15

- Objective for Today
 - Brainstorm Refined Designs
- After prototyping and testing, we did a second brainstorming session to update each member with the new ideas that were built or CADDed over the summer.
- First, we started by sketching intake/shooter mechanisms.
- For intakes, the "conveyor belt" mechanism was the most prominent idea during the discussion. It consists of chain with ^{AA} or without flaps that would move balls up as the chain moves up.
 - Possible Variations (some are included on pg. 1-32)
 - Intake Location: In previous competitions, most conveyor belt mechanisms have either one belt above or two belts on either side. Having one belt would conserve space, but having two belts on either side would have a greater intaking reach on the field.
 - Number of Flaps: Having more flaps would decrease intaking time, because the belt would have a greater intaking range more frequently.
 - Size of Flaps: Having larger flaps would increase the intaking range of the robot, because the flaps would be able to reach further than the smaller flaps. However, the smaller flaps would encompass less space, which is crucial in ~~the~~ ^{AA} this size-restricting competition.
- For shooters, members mentioned the designs they CADDed, researched, or ideas that were inspired by another member's design.
 - 3-Wheel Shooter (shown on pg. 1-54 and pg. 1-55)
 - Out of all of the wheel shooters CADDed and prototyped, one member believed that the 3-wheel shooter would be the most suitable design, because it would provide a backspin and would take up less space than a 4-wheel shooter. See ~~pg. 1-31~~ ^{AA} pg. 1-31 and 1-32 for possible variations.

Continued to page 1-85

SIGNATURE

DATE

9/2/15

DISCLOSED TO AND UNDERSTOOD BY

DATE

9/2/15

PROPRIETARY INFORMATION

Brainstorming 2 (cont.)

9/2/15

- Cam Gear Shooter (shown on pg. 1-78)
 - Two members believed that the cam gear shooter would be the most suitable design, because its shooting rate would be very fast, compared to the wheel shooters that would need time to get the wheels back up to speed after each ball shot.
 - Possible Variations
 - Distance Pulled Back: The further the launcher is pulled back, the further the ball will shoot.
 - Angle of Shooter: A 45° shooter will have an equal balance of height and range, but having an increase in angle would cause an increase in height. A decrease in angle would cause an increase in range. However, we can also change the angle with the CAD shown on pg. 1-56.
 - The Ball's Location When Shot: When the launcher is pulled back, the ball can also be pulled back, or it could be left at the top of the intake mechanism and be hit by the launcher.
- Lexan Shooter/Intake

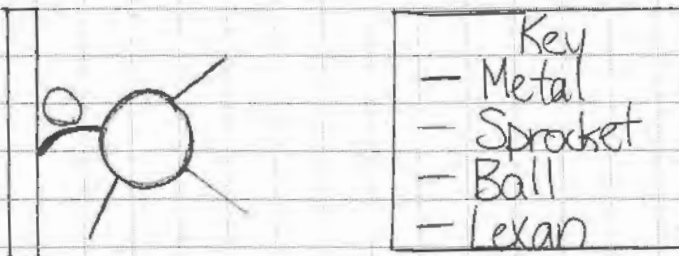

- A sprocket with chain or another cylindrical object with a metal plate wrapped around the outside would spin around with lexan sheets intaking the balls and shooting them. To shoot the balls, the lexan would bend when it makes contact with a channel, and then quickly release when it spins past the c-channel. The release would fling the ball into the air.

Continued to page 1-86

SIGNATURE

DATE

9/2/15

DISCLOSED TO AND UNDERSTOOD BY

DATE

9/2/15

PROPRIETARY INFORMATION

Brainstorming 2 (cont.)

9/2/15

- Next, we discussed elevation designs.
- Linear Slide Concept (on pg. 1-60)
 - One member believed the linear slide concept would be the best elevation mechanism because it would take up little space and would be a simple, effective design that would take little time to build.
 - Possible Variations
 - Self-Lift vs. Lifting Others: With this design, we could choose to lift ourselves by expanding the base outwards (possibly with the design on pg. 1-71), then lift the robot up so that the robot is "standing" with linear slides as "legs". We could also choose to lift our alliance partners instead.
- Ramp
 - One member believed ^{A.H.} a ramp would work well with high elevation, because it would not take up much space and would be a simple, effective design that would be easy to build.
- Next Time
 - Make Design Decisions

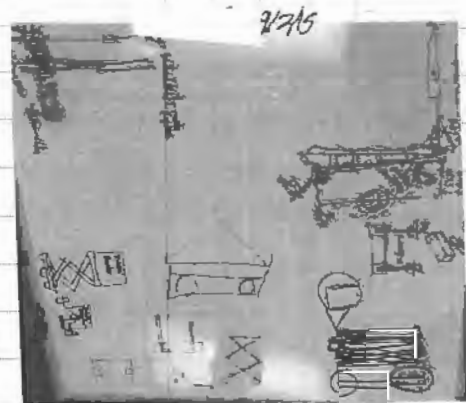

Continued to page

SIGNATURE

DATE

9/2/15

DISCLOSED TO AND UNDERSTOOD BY

DATE

9/2/15

PROPRIETARY INFORMATION

Design Decisions

9/3/15

- Objective for Today
- Make Design ~~Decisions~~^{AA} Decisions
- Today we are deciding what designs we will use for the robot. To make the selection process simpler, we created 3 decision matrices: one for the base, shooter mechanism, and elevation mechanism.
- Base Decision Matrix (scored on a 1-10 scale, with 10 being the highest possible score)

	Compatibility	Structural Integrity	Speed	Torque	Weight
X-Drive	5 • There is low compatibility, because the base must take up a lot of space, which is especially disadvantageous in this year's game.	5 • The lack of direct connections between each wheel on each side reduces the overall structural integrity.	7 • The x-drive moves quickly, because it has less torque.	4 • The wheels have less torque because there is less friction in every direction (traction) with the ground.	6 • The weight is relatively light, because there is no need for an outer c-channel running across the inside and outside of a wheel.
Total Points:					
	27				
6-Wheel Base	8.1 • There is high compatibility, because having 6 wheels would utilize the most free space in a base.	9 • The structural integrity would be high, because having 6 wheels increases the base support.	6 • The base have ^{AA} has a slightly above average speed, because it would be a direct drive and it could have a total of 6 motors that could increase the base's speed significantly.	5.5 • The base have ^{AA} wheels have ^{AA} a slightly above average amount of torque because the wheels have more power when placed together.	8.1 • The base is light, because there is no need for 45° gussets and extra c-channels at a diagonal, unlike an x-drive.
Total Points:					
	36.7				

Continued to page 88

SIGNATURE

DATE

9/3/15

DISCLOSED TO AND UNDERSTOOD BY

DATE

9/3/15

PROPRIETARY INFORMATION

Design Decisions (cont.)

9/3/15

Base Decision Matrix (cont.)

	Compatibility	Structural Integrity	Speed	Torque	Weight
4 Omni-Wheels & 2 High-Traction Wheels Total Points: 36.7	8 • The compatibility is high, because it has a balanced amount of traction and versatility.	9.1 • The structural integrity is high, because the numerous wheels provide more support.	6 • The base has a slightly above average speed, because it could have 6 motors, which would significantly increase speed.	5.6 • It has slightly more torque than a normal 6 wheel base because of the high-traction wheels.	8 • It is light, because there is no need for the extra parts needed for an x-drive.
2 Omni-Wheels & 2 High-Traction Wheels Total Points: 37.1	8.5 • The compatibility is high, because the base has an equal amount of traction on the ground and mobility.	8 • The structural integrity is high, because the wheels provide balanced support for the base.	5.6 • The base has a slightly above average speed, because it would have 4 motors. However, it would not be as fast as the base design above.	5.5 • The base has slightly more torque than a normal 4-wheel base, because it has high-traction wheels.	9.5 • It is very light, because there only are has 4 wheels, and it does not need the extra parts needed for an x-drive.
Mecanum Base Total Points: 30.5	7 • The compatibility is slightly high, because it is not able to be pushed sideways easily, which is essential in this game.	8 • The large, sturdy wheels would provide support for the base.	4 • The base is somewhat slow, because the VEX mecanum wheels are somewhat inefficient.	6 • The base has slightly more torque than a normal 4-wheel base, because of the mecanum wheels' rubber exterior.	5.5 • The mecanum wheels are somewhat heavy.

Continued to page 1-89

SIGNATURE



DATE

9/3/15

DISCLOSED TO AND UNDERSTOOD BY

lev

DATE

9/3/15

PROPRIETARY INFORMATION

Design Decisions (cont.)

9/3/15

• Base Decision Matrix (cont.)

	Compatibility	Structural Integrity	Speed	Torque	Weight
H-Base	7 • The compatibility	8 • The structural	6 • The base has	5.5 • The base has	6.8 • The base is
Total Points:	is slightly high, because the mobility is high. However, the base can be easily pushed horizontally.	integrity is high, because the numerous wheels would support the base well.	a slightly above average speed, because it would have 5-6 motors on the base.	an adequate amount of torque, because ^{A.A.} it has more wheels.	somewhat heavy, because all of the wheels would have to be omni-wheels.
	33.3				
Scissor Base	4 • The design is bulky and inefficient.	3 • The structural integrity is low, because the base ^{A.A.} is very unstable.	6 • The base has a slightly above average speed, taking into consideration its fast movement both horizontally and vertically.	5.5 • The torque is relatively average, because it would be a 4-motor, normal-wheel base.	4 • The base is very bulky and thick.
Total Points:					
	22.5				
Transmission Base	8 • The design would require the base to be wider than normal, decreasing the space for shooting and elevation mechanisms.	7 • The wheels on the base would be connected in multiple ways, increasing the structural integrity of the base.	8 • The transmission base can change to a speed ratio when needed, allowing more versatility.	8 • The transmission base can change to a ratio geared for torque when needed, allowing more versatility.	5 • The transmission base is heavy, because either pneumatics or a planetary gear would be needed.
Total Points:					
	34				

- The 2-omni-wheel and 2 high-traction wheel combination was chosen because of its high compatibility with other designs.

Continued to page 1-98

SIGNATURE

DATE

9/3/15

DISCLOSED TO AND UNDERSTOOD BY

DATE

9/3/15

PROPRIETARY INFORMATION

Design Decisions (cont.)

9/3/15

- ^{AA.} Arm Decision Matrix Shooter Decision Matrix (scored on a 1-10 scale, with 10 being the highest possible score)

	Precision	Speed	Range	Weight	Speed Compatibility
Slip Gear (Cam)	7 • The precision is high, because the balls could launch from the same spot and elasticity (provided the rubber bands are changed frequently)	7 • The slip gear can fire as soon as the cam gear makes one full revolution. There is no recharging time needed.	8 • The range is high, because the high elasticity allows the ball to shoot far. We can increase the range as needed by adding more rubber bands.	7 • The weight is somewhat light, because it only needs 2 motor ² s ^{AA.} cam gears, and aluminum.	6 • The compatibility is somewhat low, because the design will encompass a lot of space.
Total Points:					
	35				
Flywheel (Wheel Shooter)	3 • The precision is low, because the distance varies greatly based upon the speed of the wheels.	6 • The speed is somewhat low, because it needs a recharge time after each shot.	9 • The range is very high, because the high gear ratio will allow the ball to shoot far. We can increase the range by increasing the ratio.	5 • The design would be heavy, because it has multiple wheels.	4 • The compatibility is low, because the shooter lacks precision, is bulky, and usually requires at least 3 motors.
Total Points:					
	27				
Hockey Shot	7 • The precision is high, because the lexan would launch the balls at the same area. Its control is assisted by the lexan's rigidity.	6 • The design is somewhat slow, because we would have to wait before intaking more balls if the wheel is about to fling another ball.	5 • The range is somewhat low, because the lexan sheets would not have enough power to shoot the ball.	8 • The design is very light, because it is mainly made of plastic.	7 • The compatibility is high, because it uses 1 motor, is very light, and can work as an intake as well.

Continued to page 1-9

SIGNATURE

DATE

9/3/15

DISCLOSED TO AND UNDERSTOOD BY

DATE

9/3/15

PROPRIETARY INFORMATION

Design Decisions (cont.)

9/3/15

• Shooter Design Matrix (cont.)

	Precision	Speed	Range	Weight	Compatibility
Catapult	6 • The precision	5 • The speed is	5 • The range is	6 • The weight is	6 • The compatibility
Total Points:	is somewhat low, because it would be difficult to pull back the catapult to the same place each time.	low, because it would take more time for the drivers to aim at a certain area.	somewhat low, because the catapult would have little power to launch the ball.	somewhat light, because it only needs 2 motors and aluminum.	is somewhat low, because it would be difficult to load multiple ^{A.A.} balls into the robot.
	28				

- The cam gear design was chosen, because of its high range and high precision, which is vital in this year's game.
- Elevation Decision Matrix (scored on a 1-10 scale, with 10 being the highest possible score)

	Reliability	Speed	Compatibility	Weight
Scissor Base	5 • The reliability is low, because the base is very unstable.	4.5 • The lift was very slow, because it took a long time for the wheels to move toward each other while supporting the heavy design.	5 • The compatibility is low, because the base takes up a lot of space and is inefficient.	4 • The design is very bulky.
Total Points:				
	18.5			

Continued to page 1-92

SIGNATURE

DATE

9/3/15

DISCLOSED TO AND UNDERSTOOD BY

DATE

9/3/15

PROPRIETARY INFORMATION

Design Decisions (cont.)

9/3/15

Elevation Design Matrix (cont.)

	Reliability	Speed	Compatibility	Weight
Linear Slide (Self-Lift) Total Points: 27	8 • We will always be able to place ourselves on the alliance's robot, even if the other robot does not function.	4 • The speed is slow, because it will take more time to get into a position where the robot can fit below.	8 • The Compatibility is high, because it encompasses little space and provides reliability.	7 • The design is very light and requires little material.
Scissor Lift Total Points: 25	6 • The reliability is somewhat low, because scissor lifts are easy to break.	5 • The speed is somewhat high, because scissor lifts can move multiple stages at once.	8 • The compatibility is high, because the lift can go on each side of the shooter and can lift quickly.	5 • The design is somewhat heavy because it requires multiple stages of metal.
Ramp Total Points: 17.5 * The speed of the design could not be included, so the score is lower compared to the other designs. We will take this into consideration.	4.5 • The reliability is low, because its functionality depends on the functionality of our alliance partner.	N/A • It depends on how fast our alliance can move.	5 • The compatibility is low, because the design has a heavy reliance on our alliance partner, and depending on how much support the ramp needs, the extra metal would make the design bulky.	8 • The design is light, because it would not require a lot of metal. * This does not include possible parts needed for support.

Continued to page 1-93

SIGNATURE



DATE

9/3/15

DISCLOSED TO AND UNDERSTOOD BY



DATE

9/3/15

PROPRIETARY INFORMATION

Design Decisions (cont.)

9/3/15

Elevation Design Matrix (cont.)

	Reliability	Speed	Compatibility	Weight
Linear Slide (Lifting Alliance Partner)	5 • The reliability is somewhat low, because the ^{A.A.} functionality of the design depends on the weight of the alliance partner's robot.	5.1 • The speed is somewhat low, because the lifting would need a ratio geared for torque.	6 • The compatibility is somewhat high, because the design requires little space.	8.1 • The design is very light and requires little material.
Total Points:				
24.2				

• The self-lifting linear slide design was chosen, because of its high reliability and compatibility.

• Next Time
- Build Base

* Because we have already CADed each design, we will start building next meeting instead of CADDing. Some minor changes may be made, but the general design is Full Robot 2 (shown on 1-81).



Discussing Design Decisions: After discussing and deciding on the base, shooter, and elevation designs, the conveyor belt design (explained on 1-84) was unanimously chosen as the intake design because of its high versatility and compatibility.

Continued to page

SIGNATURE

DATE

9/3/15

DISCLOSED TO AND UNDERSTOOD BY

DATE

9/3/15

PROPRIETARY INFORMATION

Build Day 1

9/8/15

- Objective for Today
- Build Base
- Today, we decided what we needed in the base. On pg. 1-109, we established that we wanted a base with 2 omni-wheels and 2 high-traction wheels. We determined that we wanted a U-base, because the shooter design will take up a lot of space. We also chose to use a 3:1 speed ratio on the base, because we need to be able to cover more of the field before the opposing alliance can.
- We had a discussion about whether we should use a 2-wheel drive, or a 4-wheel drive. A 4-wheel drive would lessen the stress on each motor, but a 2-wheel drive could increase the space for the cam shooter. We decided to start with a 4-speed motor, 2-wheel drive with a 3:1 speed ratio, and if the motors cannot handle the stress, we will lessen the gear ratio on the base, or we will switch to an all-wheel drive. Using this method, we can maximize the efficiency of the base.
- We built the frame of the base and attached 3 wheels. Unfortunately, one of the axles was too long and would run into the wheel. We will fix this next meeting.
- Next Time
- Finish Base

September Week 2



- We are currently well ahead of ^{stth} schedule. We are currently in the building phase of the design process.

Continued to page 1-95

SIGNATURE

DATE

9/8/15

DISCLOSED TO AND UNDERSTOOD BY

DATE

9/8/15

PROPRIETARY INFORMATION

Build Day 1 (cont.)

9/8/15



Building the Base's Frame



Building the Base

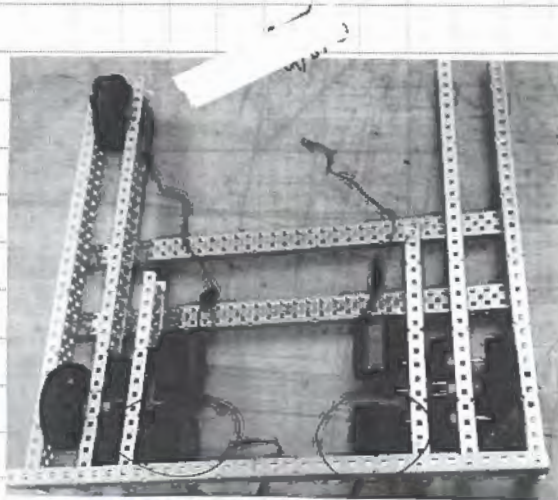

The circled motors need to be changed next meeting, because the motors came from the broken motor bin.



These axles need to be changed next meeting, because if the wheel was driven, the axles would become stuck in the wheel.

9/8/15

SIGNATURE

[Redacted signature]

Continued to page

DATE

9/8/15

DISCLOSED TO AND UNDERSTOOD BY

[Handwritten initials]

DATE

9/8/15

PROPRIETARY INFORMATION

Build Day 2 / Programming Day 1

9/9/15

- Objective for Today
- Finish Building Base

- We used a smaller axle on the base to fix the binding issue from last meeting. We attached the remaining wheel and finished building the base. We downloaded the base code onto the robot. The motor port layout is shown on pg. 1-98. We are using a tank drive, because we need simple driving code that would be easier for inexperienced drivers to use (as we have not chosen our drivers for the tournament). To eliminate confusion during wiring, the motors were labelled based on their motor port.
- Base Testing
 - When we first tested the base, it did not move forward in a straight line. At first, we thought the motor controllers were broken, so the motor controllers were replaced. However, the base did not move straight, because the back motors were loose. We will fix this next meeting (the previous back motors that were broken had already been replaced)
 - While some members built and tested the base, one member began building the cam shooter (shown on pg. 1-78). We will implement this method of specialization to increase the efficiency of our design process.
- * This year, we decided to utilize an iterative design process. Some teams have a tendency to change the design of their robot when it does not function. On the other hand, instead of attempting to familiarize ourselves with multiple designs that are very different, we plan to refine one design throughout the entire year. This allows us to create a robot that gradually improves in efficiency throughout the year.
- * Today, we realized that it would not be possible to use this base with the elevation design that we chose (the self-lifting linear slide design), because the high-traction wheels would not allow the base to expand horizontally. As a

Continued to page 1-97

SIGNATURE

DATE

9/9/15

DISCLOSED TO AND UNDERSTOOD BY

DATE

9/9/15

PROPRIETARY INFORMATION

Build Day 2 (cont.)

9/9/15

result, we will have to use a different base or a different elevation design. Since the base is already complete and is very compatible with the shooter design, we will decide on a different elevation design when the base and shooter are functional.

- Next Time
- Fix Base
- Test Base



Downloading Base Code



We need to change the back 2 motors next meeting.



We began building the shooter based on the CAD.

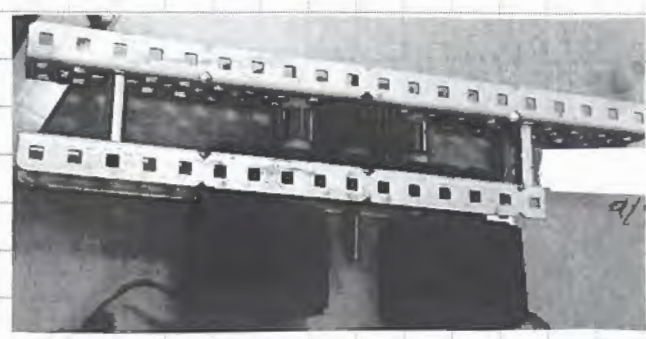

We were able to complete the cam shooter's $3\frac{1}{2}''$ 1:3 motor mount.

Continued to page 98

SIGNATURE _____
 DISCLOSED TO AND UNDERSTOOD BY _____

DATE 9/9/15

DATE 9/9/15

PROPRIETARY INFORMATION

Programming Day 1: Motor Port Layout

9/9/15

- Today we chose the motor ports for the base

Port 1: Not Used

Port 2: Not Used

Port 3: Front Left Wheel

Port 4: Back Left Wheel

Port 5: Not Used

Port 6: Not Used

Port 7: Front Right Wheel

Port 8: Back Right Wheel

Port 9: Not Used

Port 10: Not Used

- Ports 4-7 are plugged into the power expander. We placed the motors in this fashion so that the work load would be split evenly.

~~_____~~ - 9/9/15

Continued to page

SIGNATURE

~~_____~~

DATE

9/9/15

DISCLOSED TO AND UNDERSTOOD BY

A.

DATE

9/9/15

PROPRIETARY INFORMATION

Build Day 29 / Programming Day 13

10/27/15

- Objective for Today
- Program Base

- Today ~~needed~~^{A.A.} the two motors attached on October 26, 2015, were added in the code for the tank drive. The updated motor port layout is on pg. 1-149.
- We decided to test the versatility of the ramp. We asked another team, 15754, to test the ramp. The robot could not drive up, because its drive train got caught on the metal, and the base was too wide to fit on the ramp. We realized that the ramp's design is not very compatible with many robots, and that since 1575B's (the robot that could go up the ramp) robot was currently undergoing repair, it may not be ready for the competition. If they are unable to function by competition day, we will remove the ramp, because it would only be extra weight on the robot.
- We began ~~tryin~~^{A.A.} to try to make the ramp more versatile. We noticed that lighter robots were unable to counteract the weight on the ramp after they pass the pivot point, causing them to roll back down the ramp. To resolve this problem, we wrapped ~~around~~^{A.A.} rubber bands around the top of the ramp and the base of the robot to make it easier to make the pivot point turn.

- Next Time
- Driving Practice

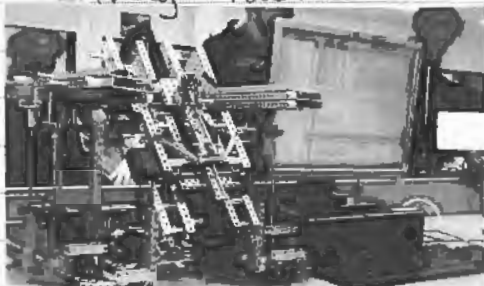

Programming the Base



Rubber Bands Attached to Ramp

Continued to page 1-149

SIGNATURE

[Signature]

DATE

10/27/15

DISCLOSED TO AND UNDERSTOOD BY

[Signature]

DATE

10/27

PROPRIETARY INFORMATION

Programming Day 13: Motor Port Layout

10/27/15

- This is the updated version of the motor ports.

Port 1: Intake

Port 2: Left Top Wheel

Port 3: Left Front Wheel

Port 4: Left Back Wheel

Port 5: Shooter Motor 1

Port 6: Shooter Motor 2

Port 7: Right Front Wheel

Port 8: Right Back Wheel

Port 9: Right Top Wheel

Port 10: Shooter Angle Adjuster

- Ports 4-7 are plugged into the power expander. This splits the workload evenly.

-10/27/15

Continued to page

SIGNATURE

DATE

10/27/15

DISCLOSED TO AND UNDERSTOOD BY

DATE

10/27/15

PROPRIETARY INFORMATION

Build Day 30/Programming Day 14

10/28/15

- Objective for Today
- Driving Practice

- We started the day by practicing driving. All of a sudden, we started hearing cracking noises. This occurred, because the internal gearing of ~~the~~ motor on the base was chipped.
- While we were replacing the broken motor, we noticed that the chain from the base's encoders (explained on pg. 1-21) was making contact with the wheels. Because of the close deadline, we decided to remove the quad encoders ^{chain AA.} to make room for the wheels. As a result, we will use time for our autonomous instead. Although we may lose some precision, using time will take less time because of its simplicity.
- The base started making cracking noises again. We will recheck all of the base motors to see if there are any discrepancies next meeting.
- Some of the motors have not been reversed, so the programming was very confusing. As a result, the motor ports were changed so that the appropriate motors were ^{Ath} reversed.

- Next Time
- Check Base Motors

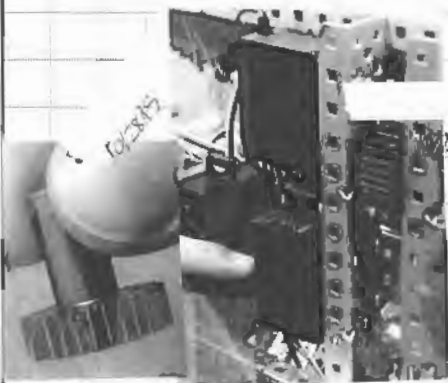

Internal Stripped Gears

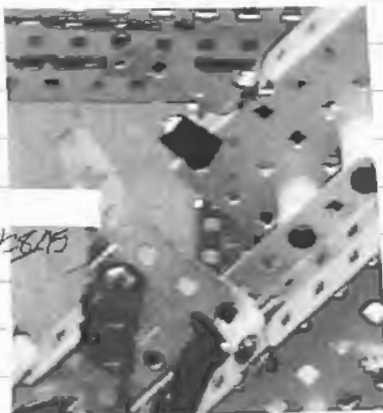

This part one-by replaced the gate, but it does not limit loading amounts.

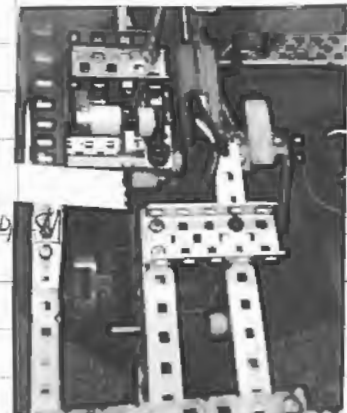

Removing Encoder Chains

Continued to page

SIGNATURE

[Redacted Signature]

DATE

10/28/15

DISCLOSED TO AND UNDERSTOOD BY

[Redacted Name]

DATE

10/28/15

PROPRIETARY INFORMATION

Build Day 31/Programming Day 15

10/29/15

- Objective for Today
- Check Base Motors
- Today we checked all of the base motors, and all of the gears in the motors had all of their teeth and were placed correctly in the motors. We believe that the cracking noises from the base (explained on pg. 1-150) is caused by the sudden change in direction. According to Newton's First Law, an object in motion stays in motion (unless an outside force is applied on the object). If a robot is at rest, it has 0 acceleration. This means that in order to make the robot move, the motors must overcome the static friction only. However, if the motors suddenly change direction, the inertia causes the wheels to continue spinning against the direction of the motors until the robot's total acceleration is 0 (which means the robot stops), and then it must overcome the static friction. The time when the motor and the wheel are spinning in opposite directions create the cracking noises.
- Taking note of this problem, we came to a full stop before going backward or changing directions. We practiced driving until the button for the angle adjuster was accidentally pushed. Because the encoder^{AA} values were never tested, code was never tested, the shooter kept moving down. We planned to shoot^{AA} right behind the barrier, because this would require the least amount of rubber bands on the shooter (which lessens the stress on the motors). As a result, we made ~~of~~^{AA} our shooter's angle constant by removing the code that would make the shooter's angle change. We kept the corkscrew in its position (even though we are not using the angle adjuster), because it adequately supports the weight of the shooter.
- We tested the autonomous shown on pg. 1-142. The robot drove forward, but the intake went the wrong way so that we outtook the balls instead. We fixed the problem

Continued to page 1-152

SIGNATURE

DATE

DISCLOSED TO AND UNDERSTOOD BY

DATE

PROPRIETARY INFORMATION

Build Day 3/Programming Day 15 (cont.)

10/29/15

- in the code, and tested it again.
- The shooter could intake in autonomous. It takes about 1.28 seconds to shoot one ball. However, sometimes one autonomous run would shoot more balls than another without changing the code. This was because the cam gear were not preset to a certain position before autonomous would start. ^{A.A} For example, if the cam was set right before it would release in autonomous, it would shoot one more than if the cam was set right after a release.
 - With the rubber links, it was easy for the ramp to release. We realized this was because we did not place the ramp's standoffs behind the rubber links. However, after this problem was solved, we still did not have an activating mechanism for the ramp. We will create one next meeting.

- Next Time
 - Test Autonomous
 - Driver Practice
 - Create Ramp Activating Mechanism



Testing Autonomous: Our robot is circled above on the blue tile.

SIGNATURE

DATE

Continued to page

DISCLOSED TO AND UNDERSTOOD BY

DATE

PROPRIETARY INFORMATION

10/29/15

10/29/15

Build Day 32 / Programming Day 16

10/30/15

- Objectives for Today
 - Test Autonomous
 - Driver Practice
 - Create Ramp Activating Mechanism
- Today, we were able to create the ramp's activating mechanism. It is similar to the rubber link-and-standoff combination we are currently using, except we used pneumatics instead of rubber links. When the pistons activate, the ramp is pushed up above the height of the standoffs, allowing the rubber bands' tension to release each stage of the ramp. When the robot goes up the ramp and reaches the top, the piston deactivates creating a horizontal plane for the robot to rest upon for more stability. The pneumatics were added in the code.
- When the ramp design was tested, it functioned as planned.
- To solve the cracking noise situation (explained on pg. 1-151), we decided to help the drivers by allowing them to switch between 80% and 100% power. Not only does this allow the base to slow down before switching directions, it also helps conserve power usage.
- Later, we had a practice match with other teams from our school in order to prepare for the tournament. Our robot was able to score 11 points in autonomous, winning the autonomous bonus. With our alliance partner, we were able to score 90 points during driver control period, while our opposing alliance scored 64 points. With the final scores of 100-64, our alliance won the practice match.
- Next Time
 - Do Well at the Competition!!!

SIGNATURE

Continued to page 154

DATE

10/30/15

DISCLOSED TO AND UNDERSTOOD BY

DATE

10/30/15

PROPRIETARY INFORMATION

Build Day 32/Programming Day 16 (cont.)

10/30/15



Resetting to Retest Autonomous

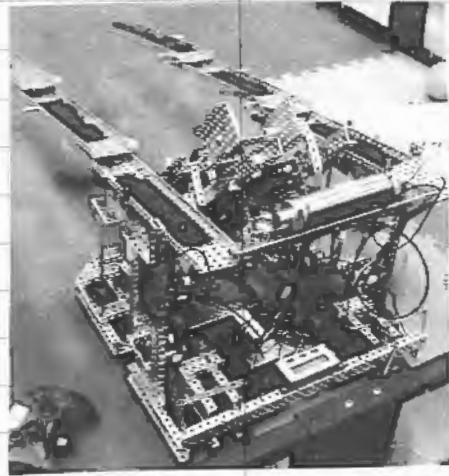

Ramp Activation Mechanism:
The circled pistons activate to deploy the ramp and deactivate to ensure the bottom of our alliance's robot is above 12".

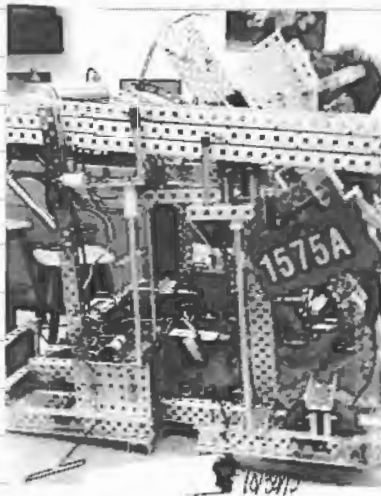

With these final adjustments, the robot is ready for the competition!

10/30/15

Continued to page

SIGNATURE

DATE

10/30/15

DISCLOSED TO AND UNDERSTOOD BY

DATE

10/30/15

PROPRIETARY INFORMATION

[Handwritten signature]

October 31, 2015: Potomac High School Competition

10/31/15

- Objectives for Today
 - Do Well at the Competition!!
- Today we tested our autonomous again to see if there were any discrepancies between our field and Potomac High School's fields. There were no major differences. However, we realized that we needed to space the balls within the intake because the autonomous's timing did not match with their locations.
- After one of our matches, we noticed that the rubber bands were getting stuck in the cam. As a result, we checked the rubber bands before and after each match and moved them away from the gear system if needed.
- During the elimination matches, the ramp was unable to deploy completely. To solve this problem, ~~we~~^{we} added more rubber bands to the stages.
- There were also matches where the ramp would inadvertently deploy during the middle of the match. To lessen the chances of this happening in a match when we planned to not use the mechanism, we wrapped rubber bands around standoffs on the stages and on extra standoffs added on the top of the main part of the robot. We wrapped the rubber bands multiple times to increase the tension and effectively hold the multiple stages back.
- Next Time
 - Post-Competition Reflection
 - Personal Statements

Continued to page 1-156

SIGNATURE

DATE

10/31/15

DISCLOSED TO AND UNDER/OWN BY

DATE

10/31/15

PROPRIETARY INFORMATION

A:

October 31, 2015: Potomac High School Competition (cont.) 10/31/15

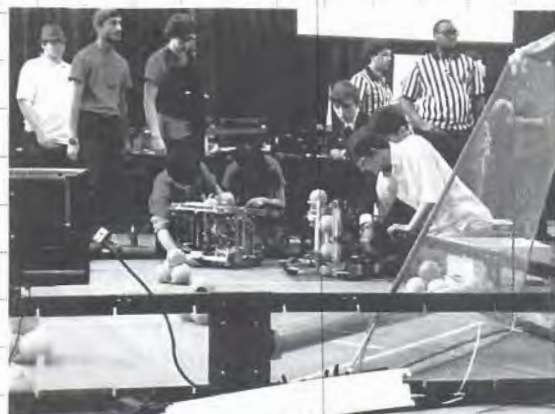
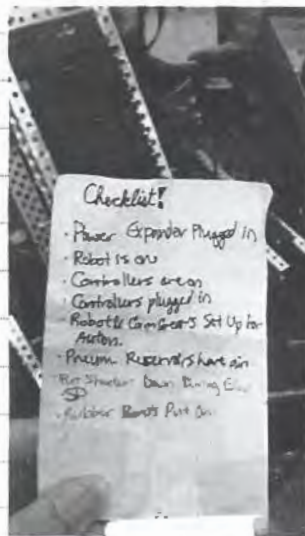
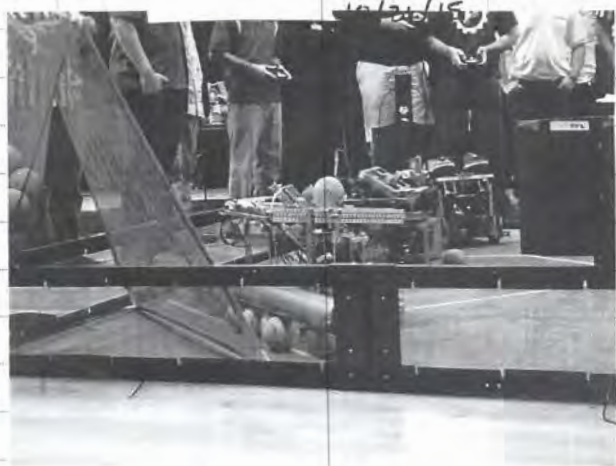

SIGNATURE

[Redacted signature]

DATE

10/31/15

Continued to page 157

DISCLOSED TO AND UNDERSTOOD BY

[Redacted name]

DATE

10/31/15

PROPRIETARY INFORMATION

October 31, 2015: Potomac High School Competition (cont)

10/31/15



10/31/15



10/31/15



10/31/15



10/31/15



10/31/15

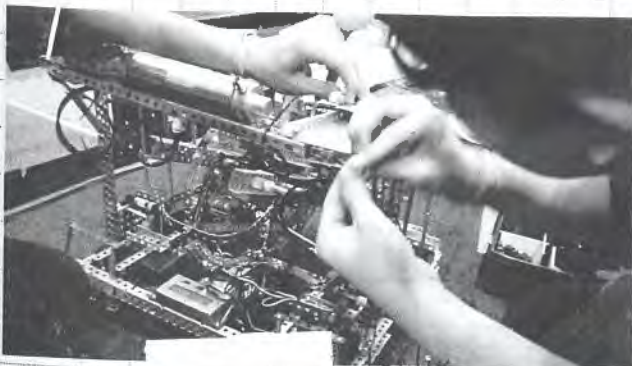

10/31/15



10/31/15

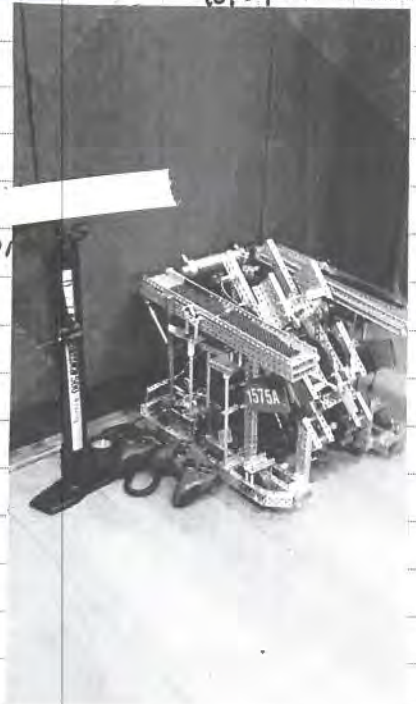

Continued to page

SIGNATURE

DATE

10/31/15

DISCLOSED TO AND UNDERSTOOD BY

DATE

10/31/15

PROPRIETARY INFORMATION

November 2, 2015: Post-Competition Reflection

11/2/15

Personal Statements

"It went well, because our autonomous worked better than expected, but although our shooter worked well, it was slow. I think we did a good job scouting and strategy wise, but at times we were a bit unorganized."

"We were up to par with the other teams at the competition, but we could have been more prepared. We were okay at the local level, but we need to improve more for the international level."

"We did well at the competition, because the robot was very consistent. However, I need to work on my coaching."

"We did okay at the competition. Our autonomous worked, but we need sensors to make it more accurate."

"Overall, we did pretty well. Our driving was okay, but our intake was bad because of the way it was set up. Some bad calls were made. However, we were able to pull through."

"The robot worked well, because everything worked as it was supposed to, besides the ramp."

"The robot was consistent, so it was an overall good day."

Post-Competition Reflection

- There were multiple things that went well at the competition.
 - Our scouting was very detailed. There was ample information on each team, so ranking teams for alliance selection was simple.
 - The checklist that we created beforehand helped. Throughout the competition, we added on more tasks. The checklist is listed below.
 - The power expander is plugged in.
 - The robot is on.
 - The controllers are on and plugged in.
 - The robot and cam gears are set up for autonomous.
 - The pneumatic reservoirs are pumped up.
 - Check if standing points should be scored.
 - Remember to put the shooter down if elevation is being done.
 - If elevation is not being done, put on rubber bands on the ramp.

Continued to page 1-15A

SIGNATURE

DATE

11/2/15

DISCLOSED TO AND UNDERSTOOD BY

DATE

11/2/15

PROPRIETARY INFORMATION

November 2, 2015: Post-Competition Reflection (cont.)

11/2/15

- For the interview, each member contributed to the discussion. Every person was very attentive and courteous to the judges.
- We had a set strategy for each match. This helped us during the competition so that we knew what to do for each ~~competit~~^{A.A} scenario in a match.
- For documentation, we used color-coded dividers to help the judges navigate the notebook. We also added analysis for pictures. We recorded some of the matches to observe how we did in the matches.
- The autonomous worked and scored 20 points as planned.
- The base was very fast and maneuverable. The base also did not die out, showing that the battery consumption is very efficient.
- For elevation, the ramp was able to lift some of our alliance partners quickly, if their robot's design was compatible with ours. Furthermore, it was able to execute ~~5'~~^{5"} high elevation, a total of 50 points.
- Our intake was functional and was able to hold 4 balls at a time.
- The shooter was very consistent. It was able to score into the high goal from the bar, which is 5-10 points per ball.
- The confidentiality of our robot's design allowed us to test our robot's design against others while not influencing other's designs. This allowed us to accurately test the effectiveness of our design.
- The battery consumption of the robot was very efficient. We only had to change our batteries once throughout the entire competition.
- Our drivers could strategically block the opposing alliance and prevent them from shooting.
- The robot was very accurate, because the drivers were able to easily line up at the bar.
- However, we can still improve upon these tasks.

Continued to page 1-160

SIGNATURE

DATE

11/2/15

DISCLOSED TO AND UNDERSTOOD BY

DATE

11/2/15

PROPRIETARY INFORMATION

November 2, 2015: Post-Competition Reflection (cont.)

11/2/15

- For the elimination matches, our alliance did not know who to pick for the third team on the alliance. As a result, we chose a team without knowing how their design worked.
- For documentation, we were unable to obtain footage of each match. This will make it harder for us to analyze how well we did for each match. The hole-punching in the binder was also inconsistent.
- The team should work on a more professional and positive outlook. The members were somewhat stressed, and it was difficult for some to keep their composure.
- During matches, we spent too much time "cherry-picking" bonus balls when we could have scored more normal balls.
- We lacked proper time management throughout the competition. As a result, we were unable to do a second driver skills run as planned.
- The coaching was also subpar. We even lost one match, because we attempted to score too much SP for the other team.
- The base was also not very sturdy. There was little room for the intake to gather balls, especially when it came to balls that were in the corners of the field or slightly under the goal pipe. Furthermore, when the base turned, the front wheels moved up off of the ground and decreased stability.
- The intake was very inefficient. The balls would get stuck in the intake. Furthermore, we could only pick up one ball at a time. When there were 2 balls next to each other, we had to intake, reverse, then intake the other ball.
- Our ramp used for high elevation was not compatible with many of the robots at the competition. The robots that had a 5-wide channel as their base frame could not go up the ramp. The ramp also could only lift robots within a certain base width, which greatly limited our compatibility. The robots also were unable to smoothly go up the ramp because of the stage overlaps (shown on pg 1-135). Sometimes, the ramp would deploy during the match before the final 30 seconds accidentally. Other times, it would not completely deploy, so the alliance

Continued to page 1-161

SIGNATURE



DATE

11/2/15

DISCLOSED TO AND UNDERSTOOD BY

DATE

PROPRIETARY INFORMATION

November 2, 2015: Post-Competition Reflection (cont.)

11/2/15

- partner's robot could not drive up.
- For autonomous, it was difficult to correctly set-up the robot due to the lack of sensors.
- During the matches, the robot kept getting blocked and pushed by the opposing alliance. We also spent a lot of time intaking. The referees even called out the drive team sometimes for their improper driving.
- The^{A.A.} From the list of things we did not do well at the competition, we created a list of what we could do to improve.
- In order to stay organized throughout the competition, we will assign specific jobs beforehand so that each member will be able to productively focus on one task. We will also add more tasks to the checklist so that we will remember everything that we need to prepare for each match.
- In order to increase our efficiency, we will practice our match strategies. We will time how long it takes to shoot a ball and see how we can reduce time.
- For the notebook, we will add an efficiency tab that will record the information explained in the above bullet. This way, we can numerically see how much we have improved. We will also calculate how cost effective the robot is compared to its scoring.
- To improve the intake, we will make a design that can pick up whole stacks and can reach under the pipe. We plan to use both top and side rollers to pick up stacks and increase our versatility.
- For the base, we need to change the spacing so that it can encompass the encoders that will improve our accuracy during autonomous and the larger intake.
- Because the ramp was functional and fast, we plan to keep the concept. However, we will redesign it so that it will be more accessible for other robots.
- Throughout the competition, our shooter was very consistent. As a result, we are simply going to ~~it's~~^{A.A.} lessen its size and allow the robot to shoot from multiple distances.

Continued to page 1-162

SIGNATURE

DATE

11/2/15

DISC USER TO AND UNDERSTOOD BY

DATE

PROPRIETARY INFORMATION

November 2, 2015: Post-Competition Reflection (cont.)11/2/15

- During the matches, we kept getting blocked by other robots. One member suggested, "Instead of trying to move around the robot, why don't we use them to line up with the goal?" Consequently, we unanimously agreed to create a setting on the shooter that can score 18" from the pipe.
- In order to improve the autonomous, we are utilizing various sensors, which will increase the autonomous's accuracy. We also plan to create a longer autonomous for skills. With the ability to shoot from various distances, we should be able to use the preloads more efficiently for autonomous.

11/2/15

Continued to page

SIGNATURE

DATE

11/2/15

DISCLOSED TO AND UNDERSTOOD BY

DATE

11/2/15

PROPRIETARY INFORMATION

Statistics for Potomac High School Competition

11/2/15

Competition at Potomac High School

Rank: 7

Wins - Losses - Ties : 5-2-0

Win Points / Score Points: (10/431)

11/2/15

Qualification Matches

Match Number	Red Alliance	Blue Alliance	Scores	Win/Loss for 1575A
8	671B 1575A	12A 671C	80 0	Win
16	177X 1575H	46B 1575A	145 142	Loss
22	5270Y 1575A	12Z 671	92 70	Win
33	8086A 12D	1575A 2068F	43 120	Win
38	1575Z 5065	1575A 1575D	13 26	Win
47	1575A 12F	12C 1575B	66 57	Win
59	6740 12B	6603F 1575A	173 106	Loss
Average			90.3	

Continued to page 1-164

SIGNATURE

DATE

11/2/15

DISCLOSED TO AND UNDERSTOOD BY

DATE

11/2/15

PROPRIETARY INFORMATION

Statistics for Potomac High School Competition (cont.)

11/2/15

Quarterfinals

Match Number	Red Alliance	Blue Alliance	Scores	Win/Loss for 1575A
4-1	46A 1575A	4303C 180	133 118	Win
4-2	1575A 671C	4303C 2068G	124 142	Loss
4-3	46A 1575A	4303C 180	140 135	Win
Average			132.3	

Semifinals

Match Number	Red Alliance	Blue Alliance	Scores	Win/Loss for 1575A
2-1	12B 46B	46A 1575A	155 178	Win
2-2	46B 1575C	1575A 671C	114 85	Loss
2-3	12B 46B	46A 1575A	125 277	Win
Average			180	

11/2/15

Continued to page 1-165

SIGNATURE

DATE

11/2/15

DISCLOSED TO AND UNDERSTOOD BY

DATE

11/2/15

PROPRIETARY INFORMATION

Statistics for Potomac High School Competition (cont.)

11/2/15

Finals

Match Number	Red Alliance	Blue Alliance	Scores	Win/Loss for 1575A
1-1	6740B	46A	124	Loss
	1575V	1575A	101	
1-2	6740B	1575A	182	Loss
	8086A	671C	77	
Average			89	

Average Performance for Each Match: 108.8

Average Performance at the Competition: 97.9

- During the competition, we were able to score approximately 9-20 balls each match (depending on whether the balls scored were balls or bonus balls). We were in the top 20% for the rankings, which is a good indication of how we compare to other robots in the region. However, we will not stop trying to improve until we make it to world's!!!

11/2/15

Continued to page

SIGNATURE

DATE

DISCLOSED TO AND UNDERSTOOD BY

DATE

11/2/15

11/2/15

PROPRIETARY INFORMATION

November Schedule

11/2/15

November 2015

Sun	Mon	Tue	Wed	Thu	Fri	Sat
1	2 <i>Post-Competition Reflection</i>	3 <i>Fix Problems From Competition</i>	4 <i>Holy Family Catholic School Mentoring Fix Problems From Competition</i>	5 <i>Fix Problems From Competition</i>	6 <i>FLL Competition Volunteering Fix Problems From Competition</i>	7 <i>FLL Competition Volunteering</i>
8	9 <i>Test Autonomous Driving Practice</i>	10 <i>Test Autonomous Driving Practice</i>	11 <i>Veterans Day</i>	12 <i>Test Autonomous Driving Practice</i>	13 <i>Test Autonomous Driving Practice Efficiency Testing</i>	14 <i>Holy Family Catholic School Mentoring Test Autonomous Driving Practice Efficiency Testing</i>
15	16 <i>Test Autonomous Driving Practice</i>	17 <i>Test Autonomous Driving Practice</i>	18 <i>Holy Family Catholic School Mentoring Test Autonomous Driving Practice</i>	19 <i>Test Autonomous Driving Practice Efficiency Testing</i>	20 <i>Test Autonomous Driving Practice Presentation Practice</i>	21 <i>Woodrow Wilson High School Tournament</i>
22	23 <i>Post-Competition Reflection</i>	24 <i>Fix Problems From Competition</i>	25 <i>Thanksgiving Break</i>	26 <i>Thanksgiving Break</i>	27 <i>Thanksgiving Break</i>	28
29	30 <i>Fix Problems From Competition</i>					

11/2/15

November Schedule

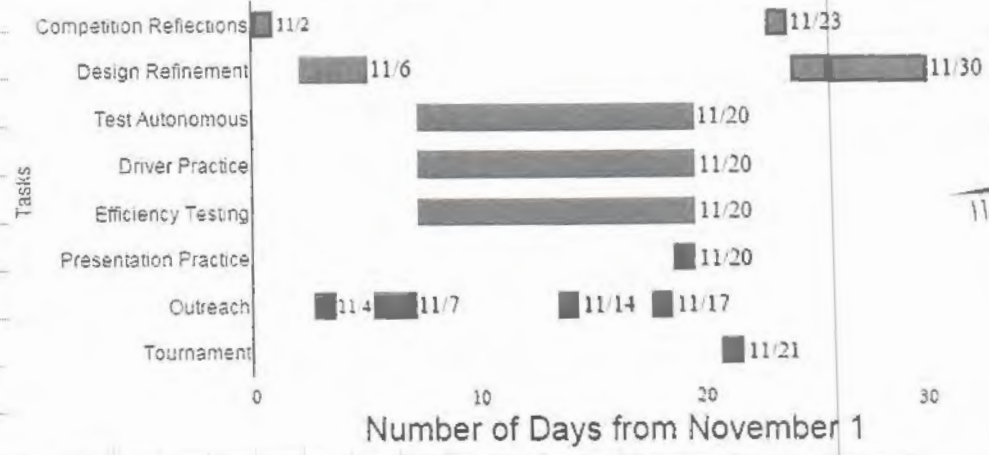

11/2/15

Continued to page

SIGNATURE

DATE 11/2/15

DISCLOSED TO AND UNDERSTOOD BY

DATE 11/2/15

PROPRIETARY INFORMATION

Build Day 3311/3/15

- Objectives for Today
 - Build Base
 - Disassemble Old Base
- Today we created a more specific list of what we wanted from the base.
 - Higher Speed Capability: During one of our matches, a robot made contact with our robot in the autonomous period. As a result, we did not score the balls as planned. If we are able to go faster, we can fully avoid other robots that attempt to disrupt our autonomous.
 - Space to place Encoders: We need enough space to place encoders on the rear wheels of the robot, so our robot can accurately move during autonomous.
 - Space to Place Intake: Since we want our intake to be able to have a wider range, we decided that the front of the intake should reach past the front of the base. Consequently, the base must have a shorter length.
- From this list, we decided to keep the same general design for the base (4 3.25" omni-wheels with a U-base), except with a 5:1 gear ratio instead of a 3:1 gear ratio. Instead of a 35-hole long C-channel as the robot frame's length, we used a 25-hole long C-channel. We are still using 6 torque motors on the base.
- To speed up the process, we assigned some members to disassemble the base while other members created the new design. We separated the old robot into the subassemblies (ramp, intake, shooter, base) so that we could separately salvage certain designs.
- While others were disassembling the robot, the members building the new base faced a problem: there were no 25-hole long C-channels available. We decided to use 30-hole long C-channels that we could use now. If

SIGNATURE

DATE

Continued to page 1-168

DISCLOSED TO AND UNDERSTOOD BY

DATE

PROPRIETARY INFORMATION

Su

11/3/15

11/3/15

Build Day 33 (cont.)

11/3/15

- the new intake requires more space, we will change the c-channel to a 25-hole long. However, using a 30-hole long will give the robot more stability.
- We were able to complete the base and attach the encoders.
 - We downloaded code to the base and tested it at 60% power, because we will mainly be using the base at full power for autonomous only.
 - The base could function. However, it ~~base~~ ^{A.A.} slightly curved when we pushed the joysticks to go forward. We believe that this occurred, because the battery was dragging on the ground. The extra friction most likely changed the results. Furthermore, when the encoders are coded, this problem can be solved with software.
 - We decided not to double the ~~bevels~~ ^{up on A.A.} on the intake, because it may grind gears.
 - We continued to build more of the shooter, making the angle of it high for the shooter so that it has high parabola.
 - We replaced the robot's current slide with a smaller one so it may be more compact and fit better with the shooter and base.

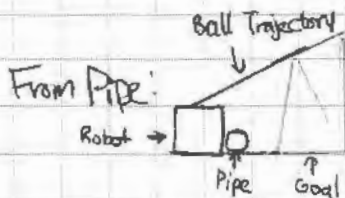

18" From Pipe:

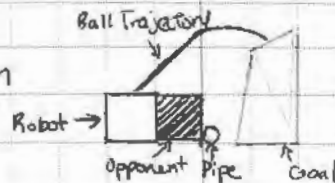

- With one rubber band setting, we will shoot from 2 different places.

- Rubber bands slipped off the back of the hammer, so we made a stand that will pull rubber bands to the middle of the base.
- We decided to change the shooter back to its original design with rubber bands, but changed the angle of it to be higher.
- We were able to wire the shooter.
- The intake was removed, so we could redesign the mechanism.

Continued to page 1-169

SIGNATURE

[Signature]

DATE

11/3/15

DISCLOSED TO AND UNDERSTOOD BY

[Signature]

DATE

11/3/15

PROPRIETARY INFORMATION

Build Day 33 (cont.)

11/3/15

- Next Time
 - Build Intake
 - Use Encoders in Code

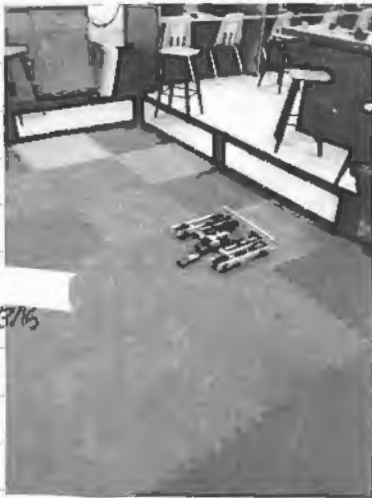

11/3/15

Testing the 5:1 Base

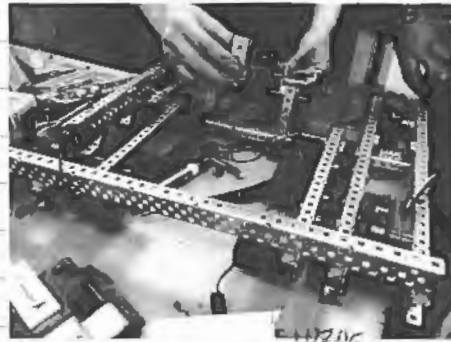

11/3/15

Replacing the Shooter's Slide

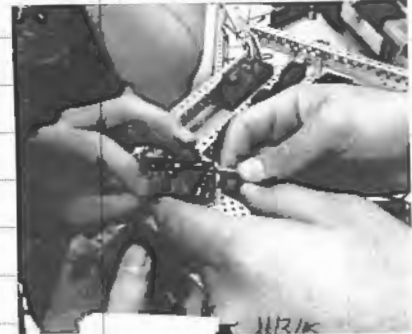

11/3/15

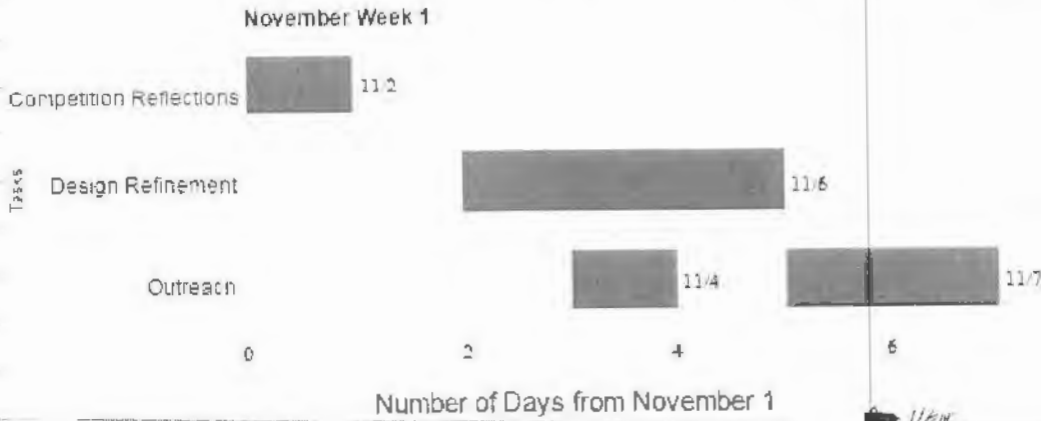

Double Bevel Gear Design:
We decided to not use this design, because the gears may not be able to withstand the stress.



11/3/15

• We will continue to refine the robot's design.

Continued to page

SIGNATURE

 DISCLOSED TO AND UNDERSTOOD BY



DATE
 11/3/15

DATE
 11/3/15

PROPRIETARY INFORMATION

Build Day 34 / Programming Day 17

11/4/15

- Objectives for Today
 - Build Intake
 - Use Encoders in Code
- Today we added a truss between the base and the back of the shooter for more structural support.
- Next, we began building the intake. It consisted of 4 18-tooth sprockets separated by spacers on the bottom to intake from the field. In the back, there was a conveyor belt-like mechanism that  brings the balls up to the shooter. We used comparatively large sprockets to have a wider intaking range. We completed building this design.
- However, later we disassembled the intake because it was not compatible with the robot. The design didn't fit properly, it wasn't able to mount on the base, and no space was available for it.
- We combined the two different assemblies into one to increase the speed and reliability of the intake.
- We coded base encoders.
- We changed autonomous from time to distance in the code,  to increase the accuracy of our program.

- Next Time
 - Finish LCD code
 - Add top rollers and funnels



Building the Intake

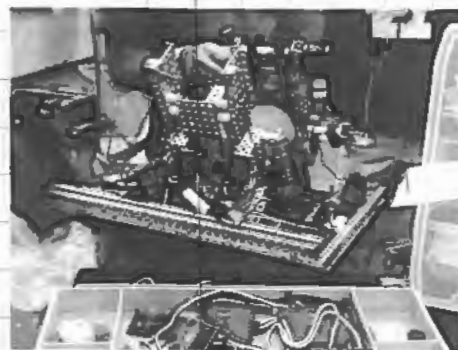

Mounting the Intake

Continued to page 1-171

SIGNATURE

DATE

11/4/15

DISCLOSED TO AND UNDERSTOOD BY

DATE

11/4/15

PROPRIETARY INFORMATION

Build Day 34 / Programming Day 17 (Cont.)

11/4/15

Front View

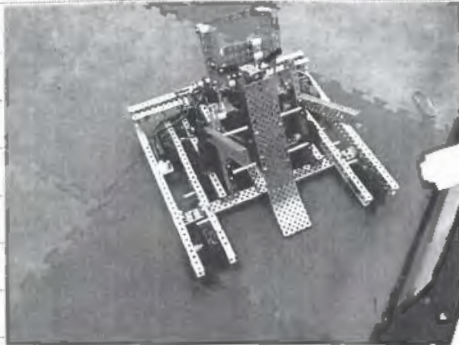

11/4/15

Isometric View

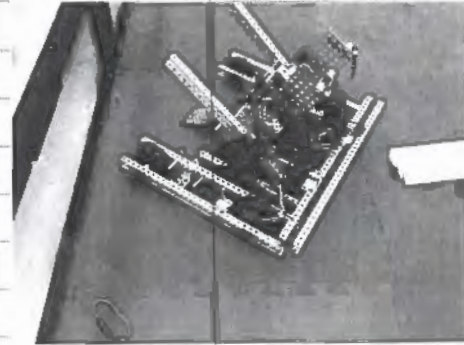

11/4/15

Final product of the day

11/4/15

Continued to page

SIGNATURE

DATE

11/4/15

DISCLOSED TO AND UNDERSTOOD BY

DATE

11/4/15

PROPRIETARY INFORMATION

Build Day 35 / Programming Day 18

11/5/15

- Objectives for Today
 - Finish LCD Code
 - Add Top Rollers and Funnels
- Today we began reconstructing the intake. As explained on pg. 1-170, we will combine both the top roller and the conveyor belt that moves the balls up to the shooter to increase stability. We decided to use a 3:2 speed ratio powered by one speed motor so that the intake can quickly gather balls. We also created a top roller with alternating sprockets with spacers and a conveyor belt that has 3 adjacent chains to increase control of the field objects.
- On the intake, we added funnels to assist the drivers. Adding the one-by funnel will allow all of the balls to be intaken in one line into the shooter while adding little weight.
- We also completed the LCD code. With the LCD code, we can choose between 8 different options quickly and easily.
- Next Time
 - Test Intake

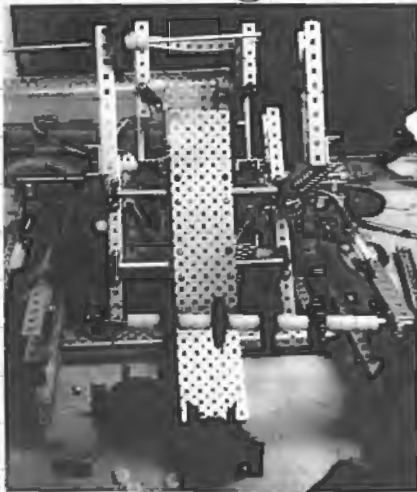

Building Intake



Testing Intake



Adding Chain

Continued to page

SIGNATURE

DATE

11/5/15

DISCLOSED TO AND UNDERSTOOD BY

DATE

11/5/15

PROPRIETARY INFORMATION

Build Day 36

11/6/15

- Objectives for Today

- Build Intake
- Test 3 Tread Rollers

- Today we attempted using 3 tread rollers in our intake. When tested, the balls got jammed because the spacing was poor. We attached a funnel to the sides, but it did not improve.
- We added c-channels to reduce the width of the intake's funnel because it was too large.
- We then removed the funnel completely because it caused the intake to jam and broke its chain.
- The base motors were loose because they were being worn down over time.
- We added rubber bands onto the batteries to temporarily hold them in place, rather than using zip ties so we wouldn't have to continue wasting them.

- Next Time

- Continue testing intake designs



11/6/15
Temporary
Battery
Mount



11/6/15

Continued to page 1-174

SIGNATURE

DATE

11/6/15

DISCLOSED TO AND UNDERSTOOD BY

DATE

11/6/15

PROPRIETARY INFORMATION

Build Day 36 (cont.)

11/6/15

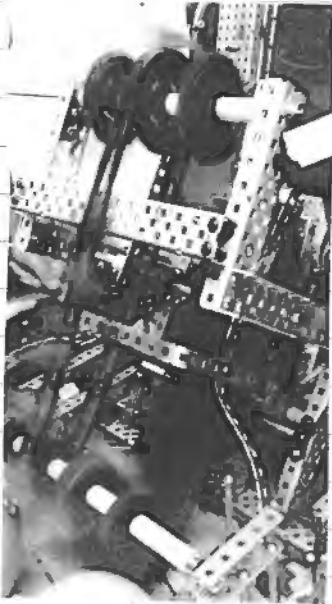

11/6/15

Intake in Action



11/6/15

Tightening Base Motors



11/6/15

Removing Bottom of Intake

11/6/15

Continued to page

SIGNATURE

DATE

11/6/15

DISCLOSED TO AND UNDERSTOOD BY

DATE

11/6/15

PROPRIETARY INFORMATION

Build Day 37

11/9/15

- Objectives for Today
 - Build Side Rollers
 - Test Intake Designs
- Today, ^{we} changed the intake design. We decided to use side rollers ~~instead~~ ^{instead} instead of top rollers to see which was more functional.
- The Flaps attached to the side rollers did not leave enough space for balls to move through when it was tested.
- We then decided to test the intake using grippy treads on the side rollers instead, hoping the friction between them and the balls would let them move up more efficiently. If this didn't work, we would then move the side rollers back one space.
- Both designs did not work because the balls were not easily moving through the intake. As a result, we decided to change the intake back to top rollers. This allowed the balls to have more space to move through.
- We discussed different intake designs, including team 2R's.

The rotating c-channel allows a small amount of flexibility so that the intake can go over any impediments.



Side View



Front View

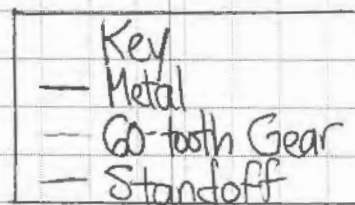

- The top roller spins and it pulls balls into a secondary top roller. As the top roller approaches the ball, it will engulf the ball by elevating, then dropping the roller.
- Next Time: Continue Building Intake

Continued to page 176

SIGNATURE

DATE

11/9/15

DISCLOSED TO AND UNDERSTOOD BY

DATE

11/9/15

PROPRIETARY INFORMATION

Build Day 37 (cont.)

11/9/15

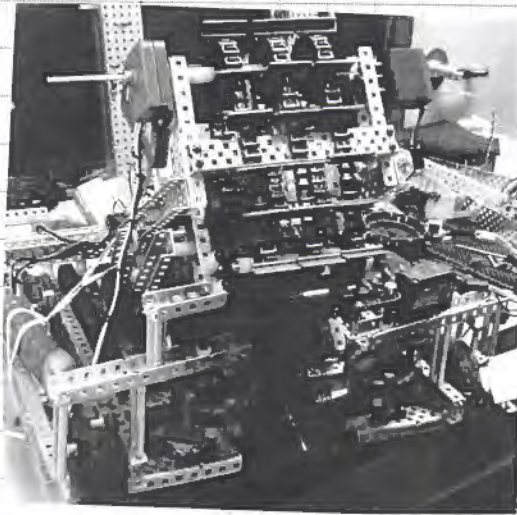

Side Roller with ~~B~~ Treads that Have a Rubber Exterior

11/9/15

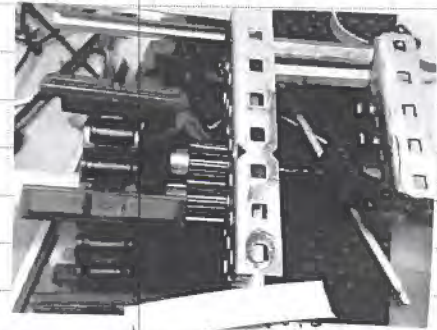

11/9/15

Although we wanted to use side rollers, they were not compatible with the robot's design.

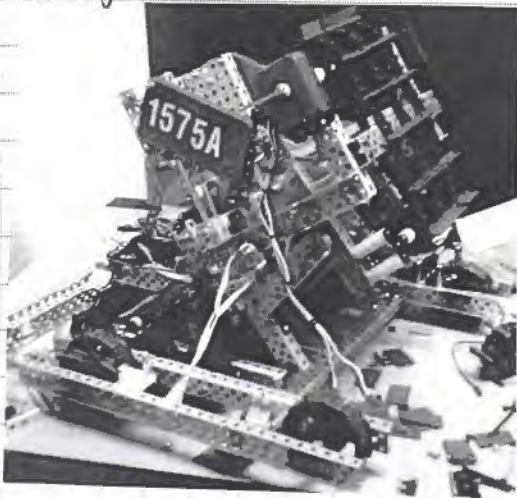

11/9/15

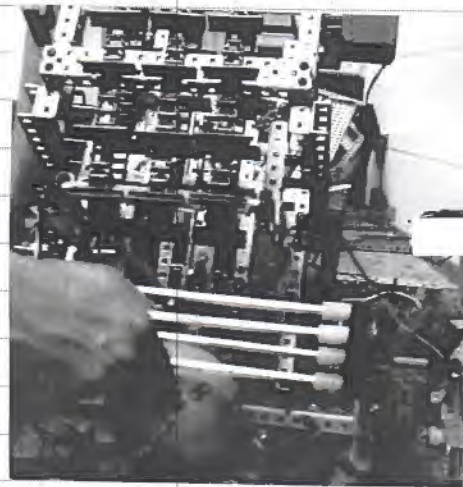

11/9/15

Creating the Standoff Intake

Removing Side Rollers

11/9/15

SIGNATURE

[Signature]

DATE

11/9/15

Continued to page 1-177

DISCLOSED TO AND UNDERSTOOD BY

tu

DATE

11/9/15

PROPRIETARY INFORMATION

Build Day 37 (cont.)

11/9/15

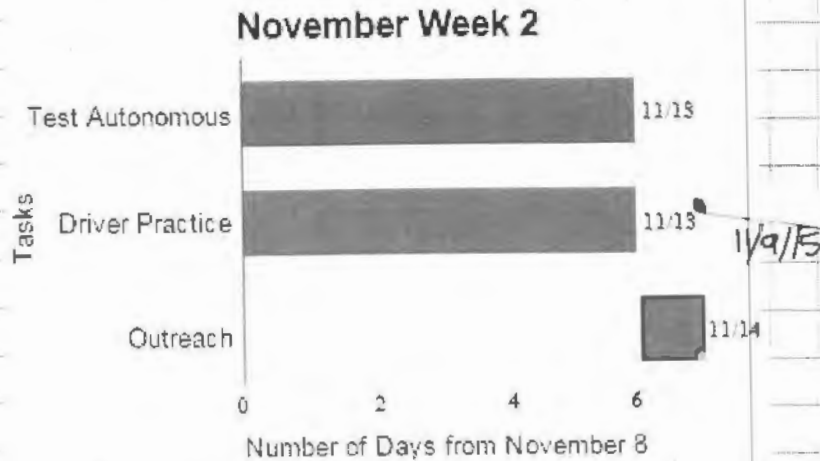

- We are currently slightly behind on schedule, but will most likely be able to practice driving and test the autonomous by the end of the week.

11/9/15

Continued to page

SIGNATURE

[Redacted Signature]

DATE

11/9/15

DISCLOSED TO AND UNDERSTOOD BY

mi

DATE

11/9/15

PROPRIETARY INFORMATION

Build Day 40 / Programming Day 19 / Efficiency Test 1

11/13/15

- Objectives for Today
 - Test Efficiency
 - Driving Practice

• Today we practiced driving. We noticed that the axle for the shooter kept falling out on one side. After replacing the faulty collar causing the issue, the shooter could function.

* To test efficiency, we decided to measure the amount of time it takes for us to do certain tasks. We will attempt to do efficiency tests at least once a week to see how much we improve, and if we improve. For each task, we will have at least 3 trials to ~~the~~^{AA} improve the validity of our results.

• Baseline Testing

• For our first efficiency test, we timed how long it took for us to intake one ball pyramid located directly against the wall. The robot was placed with its center at the intersection of the 4 field tiles closest to the pyramid. The efficiency test set-up is shown on pg. 1-184.

Intaking the Pyramid by the Wall

Trial	Time (in Seconds)
1	7.42
2	8.27
3	9.55
4	10.46
5	7.32
6	5.49

• On average, it took 8.085 seconds for the robot to intake one pyramid ~~balls~~^{AA} approximately 2.02 seconds per ball.

Continued to page 1-183

SIGNATURE

DATE

11/13/15

DISCLOSED TO AND UNDERSTOOD BY

DATE

11/13/15

PROPRIETARY INFORMATION

Build Day 40/Programming Day 19/Efficiency Test 1 (cont.)

11/13/15

- Next, we timed how long it took to shoot 4 balls (already loaded into the intake) from the pipe.

Trial	Time (in Seconds)	If it Reached the High Goal (Y: Yes, N: No)			
		Ball 1	Ball 2	Ball 3	Ball 4
1	14.39	N	Y	Y	Y
2	11.31	Y	N	Y	N
3	15.36	N	N	Y	Y
4	12.25	Y	Y	N	Y
5	13.87	N	N	N	N
A.A.					

- On average, it took 13.436 seconds to shoot all 4 balls (approximately 3.36 seconds per ball). We were able to shoot the balls into the high goal 50% of the time.
- We were able to finish attaching the line follower onto the top of the intake. The sensor will allow the robot to determine whether ~~or~~^{A.A.} or not there is a ball in the shooting area. The updated motor and sensor setup is shown on pg. 1-185 & 186.

- Next Time
- Test Autonomous

11/13/15

Continued to page 1-184

SIGNATURE *[Signature]*

DATE 11/13/15

DISCLOSED TO AND UNDERSTOOD BY *[Signature]*

DATE 11/13/15

PROPRIETARY INFORMATION

Build Day 40 / Programming Day 19 / Efficiency Test 1 (cont.)

11/13/15



11/13/15

Replacing the Collar



11/13/15

Attaching the Sensor



11/13/15

Setting Up the Robot for Shooting from the Pipe

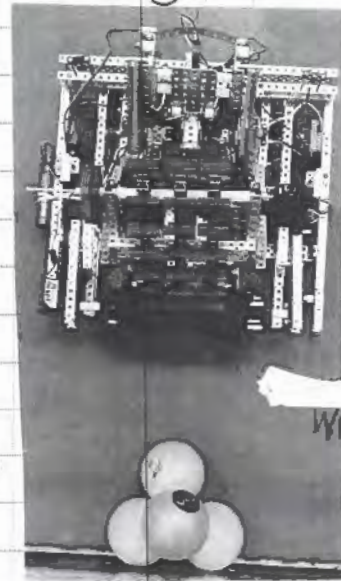

11/13/15

Setting up the Robot for Intaking a Pyramid

11/13/15

Continued to page

SIGNATURE

DATE

11/13/15

DISCLOSED TO AND UNDERSTOOD BY

DATE

11/13/15

PROPRIETARY INFORMATION

Programming Day 19: Motor & Sensor Port Layout

11/13/15

- This is the updated version of the motor ports.

Port 1: Intake Motor 1

Port 2: Left Front ~~Wheel~~^{A.A.} ~~Gear~~^{A.A.} Wheel

Port 3: Left Middle Wheel

Port 4: Left Rear Wheel

Port 5: Shooter Motor 1

Port 6: Shooter Motor 2

Port 7: Right Middle Wheel

Port 8: Right Rear Wheel

Port 9: Right Front Wheel

Port 10: Intake Motor 2

- Ports 4-7 are plugged into the power expander to split the workload evenly.

11/13/15

Continued to page 1-186

SIGNATURE

[Signature]

DATE

11/13/15

DISCLOSED TO AND UNDERSTOOD BY

[Signature]

DATE

11/13/15

PROPRIETARY INFORMATION

Programming Day 19: Motor & Sensor Port Layout (cont)

11/13/15

• Analog Sensor Setup

Port 1: Ball Detector (Line Follower)
 Port 2: Not Used
 Port 3: Not Used
 Port 4: Not Used
 Port 5: Not Used
 Port 6: Not Used
 Port 7: Not Used
 Port 8: Not Used

• Digital Sensor Setup

Port 1: Left Base (Quad Encoder)
 Port 2: Not Used
 Port 3: Right Base (Quad Encoder)
 Port 4: Not Used
 Port 5: Shooter (Quad Encoder)
 Port 6: Not Used
 Port 7: Not Used
 Port 8: Not Used
 Port 9: Not Used
 Port 10: Not Used
 Port 11: Not Used
 Port 12: Elevation Piston (Actuator)

11/13/15

Continued to page

SIGNATURE

DATE

11/13/15

DISCLOSED TO AND UNDERSTOOD BY

DATE

11/13/15

PROPRIETARY INFORMATION

November 2nd, 2015: Woodrow Wilson High School Competition

11/2/15

Objectives for Today

- Fix Base
- Do Well at the Competition!!

- To fix the base, we changed which motor ports were plugged into the power expander. We plugged in ports 3, 4, 8, and 6, three of which are base motors. With this change in power distribution, the base was able function without stopping for more than 2 minutes.
- Last meeting, we changed the code significantly. However, when we arrived at competition, the program was nowhere to be found. We realized that we left the code behind! Fortunately, we were able to retrieve the newest version of code from the notebook, and resolve our problem.
- Throughout the day, various wires ~~to~~^{at} kept becoming unplugged, especially the base encoders. Because it was difficult to determine which motor went into which port with the complex wiring, we decided to leave the encoders unplugged on the base and use time to drive the base during autonomous. To compensate for the decreased inaccuracy from using time, we changed the autonomous so that it would ram the pipe twice. The first time is when the robot would reach the pipe, and the second time is when the robot would line up with the pipe.
- During one of the matches, the truss on the shooter and base came loose. This caused the balls to get stuck on the loose c-channel, decreasing the efficiency of the intake. After removing the c-channel, the intaking improved. Although the robot has less structural support, we realized that the truss had little effect, because the robot functioned the same without it.

Next Time

- Post-Competition Reflection

SIGNATURE

Continued to page 1-202

DATE

11/2/15

DISCLOSED TO AND UNDERSTOOD BY

DATE

11/2/15

PROPRIETARY INFORMATION

November 21st, 2015. Woodrow Wilson High School Competition (cont)

11/21/15

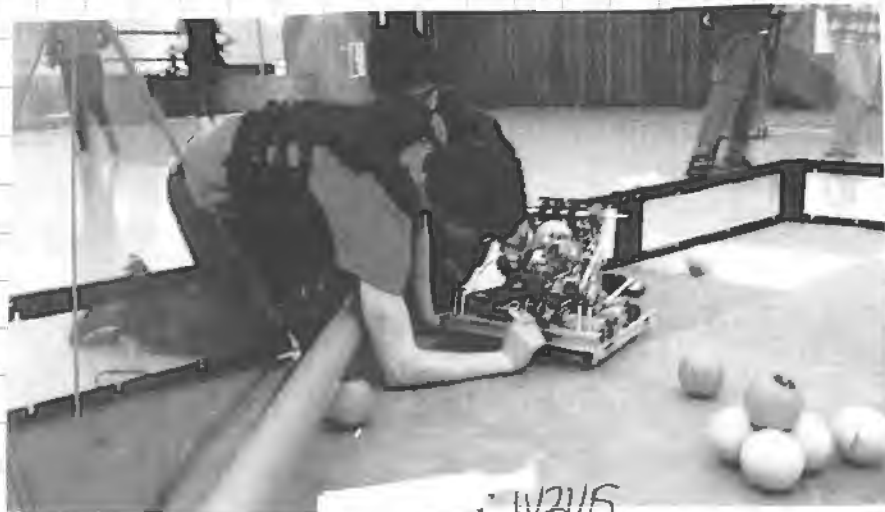

Getting Ready for Driver Practice



Retrieving the Newest Version of Code

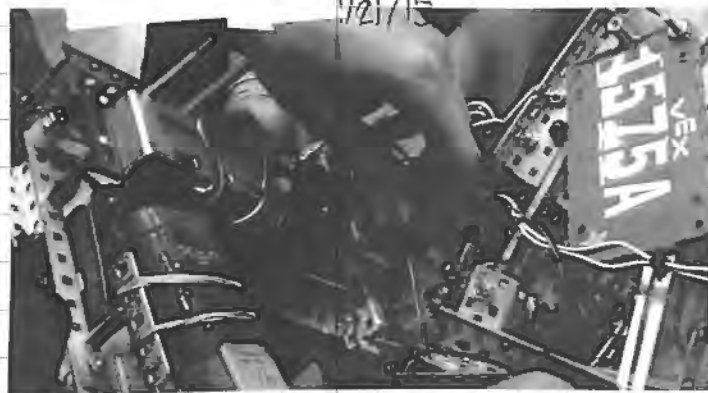

Throughout the day, we had problems with the wires' plugs coming out of their ports. The first picture shows us tracing the location of one ~~motor~~ unplugged motor. The second picture shows us pushing in 4 plugs that came out during a match.

Continued to page 1-203

SIGNATURE

DATE

11/21/15

DISCLOSED TO AND UNDERSTOOD BY

DATE

11/21/15

PROPRIETARY INFORMATION

Ai

November 21st, 2015: Woodrow Wilson High School Competition (cont.)

11/21/15

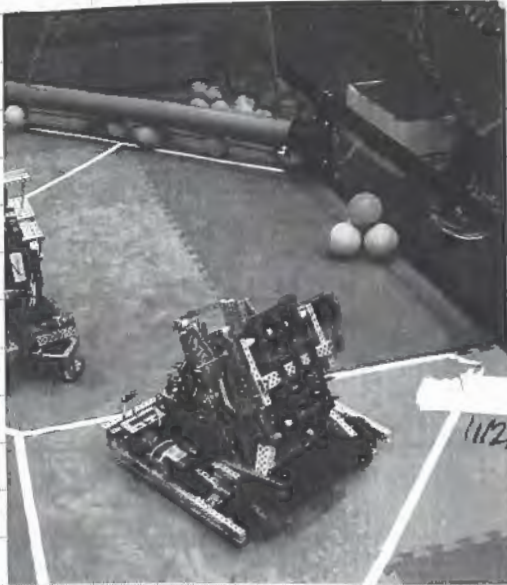

Qualification Match Close-Up

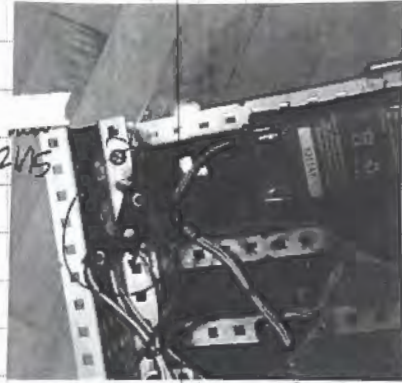

The bearing circled above ~~was~~ snapped, because the base was driven too quickly into the pipe.



Preparing for Elimination Matches



Beginning a Match in the Finals

SIGNATURE

Continued to page

DATE

11/21/15

DISCLOSED TO AND UNDERSTOOD BY

DATE

11/21/15

PROPRIETARY INFORMATION

November 23, 2015: Post-Competition Reflection

11/23/15

Personal Statements

- ... "The competition was not the day it should have been. We got better throughout the day, but we spent the day catching up to where we should have been at the start of the tournament."
- ... "I think we had issues with consistency."
- ... "We had a lot of miscommunication throughout the day. The driver and programming skills were poor. Mistakes were also made during the judges' interview; however, the base worked very well."
- ... "We struggled with intaking and talking at the judges' interview, but our robot was able to work by the end of the day."
- ... "We had a lot of inconsistencies in the beginning, but we worked out the kinks and were able to persevere."
- ... "The autonomous performed poorly for the first half of the competition, but we practiced a lot with driving."
- ... "Towards the beginning, our robot had a few problems, but we got it working eventually. The autonomous worked well, and we did our best during the final matches."

Post-Competition Reflection

- * To keep a focus on the scientific, professional aspect in the notebook, we will only include the portions of the reflection that pertain to the robot's design in the notebook (including code).
- There were some aspects of the competition that went well.
 - The 5:1 speed base was very fast, which allowed us to reach the balls faster on the field than other robots. It also gave us an advantage during the autonomous period. Because our robot was faster than most of the robots in the competition, we did not make contact with them. As a result, the opposing alliance was unable to interfere with our autonomous by running into the robot.
 - Our autonomous program (at the end of the day)

Continued to page 1-205

SIGNATURE

DATE

11/23/15

DISCLOSED TO AND UNDERSTOOD BY

DATE

11/23/15

PROPRIETARY INFORMATION

November 23, 2015: Post-Competition Reflection (cont.)

11/23/15

- Post-Competition Reflection (cont.)
functioned well. The program incorporated various sensors that increased the accuracy and precision of the robot's movement. With the correct set-up, the robot could implement the program as planned each time.
- However, some aspects of the robot[^] did not work well.
 - The precision of the shooter was low at the start of the competition. This was due to the rubber bands snapping off during the matches.
 - The intake also got jammed when multiple balls were being intaken. Furthermore, the balls could fall out of the shooter whenever the driver intook too much. Although this is primarily a driving problem, it also demonstrates the ineffectiveness of the steel one-by that helps to control the intaking of the balls. This was most likely caused by the one-by not being bent to the proper position.
 - The time management for the design process was not run well. Because we did not monitor our time properly, we were unable to attach our elevation mechanism in time.
 - The wiring on the robot was very unorganized and complex. Consequently, we spent a lot of time trying to determine which ports were plugged in, instead of practicing driving.
- * Our robot was unable to rank high on driver skills nor programming skills, even though our shooter and our robot as a whole worked correctly. We realized that this was because our robot is unable to shoot the balls from our alliance tile. While full-court shooters could stay in their tile and shoot 24 loads, our robot has to drive and shoot, significantly reducing our time to actually score. Furthermore, during matches, we are almost entirely reliant on our alliance partner for efficiently scoring driver control loads.
- In order to refine our robot's design and improve its performance at future competitions, we are

SIGNATURE

DISCLOSED TO AND UNDERSTOOD BY

DATE

Continued to page 1-206

11/23/15

DATE

11/23/15

PROPRIETARY INFORMATION

November 23, 2015: Post-Competition Reflection (cont.)

11/23/15

changing the following things.

- * First and foremost, we need to create a full-court shooter design that shoots approximately 116.30" (see pg. 1-107). This will allow us to drastically increase our scores during matches and during skills.
- We will reorganize the wiring on the robot so that all of the ports will be easily accessible by hand. This will prevent us from wasting much-needed time on an otherwise simple task.
- In order to increase our efficiency as a robot that gathers balls from the field, we will change our 3.25" wheels on the base to 4" wheels. This will allow us to cover the field in significantly less time, and have more time to shoot from full-court.
- We will also improve the efficiency of our intake. This will allow us to gather[^] balls from the field[^] faster, preventing the opposing alliance from scoring them instead.
- To ensure the shooter maintains its accuracy and precision during matches, we will add "Check shooter's rubber bands" to the competition checklist (shown on pg. 1-158).
- We will also attach a high elevation mechanism onto the robot.
- * Although improving our intake and attaching an elevation mechanism is very important, we consider designing the full-court shooter as a more pressing issue because the full-court shooter can be loaded by hand, and scoring driver control loads into the high goal can generate over double the points from high elevation (120 points vs. 50 points). As a result, we will work on the intake and elevation mechanism after our next competition.

Continued to page

SIGNATURE

DATE

11/23/15

DISCLOSED TO AND UNDERSTOOD BY

DATE

Aci

11/23/15

PROPRIETARY INFORMATION

Statistics for Woodrow Wilson High School Competition

11/23/15

Competition at Woodrow Wilson High School

Rank: 14

Wins - Losses - Ties : 3-3-0

Win Points / Score Points: (6/451)

11/23/15

Qualification Matches

Match Number	Red Alliance	Blue Alliance	Scores	Win/Loss for 1575A
6	3623A	1575A	117	Loss
	8956A	1575B	71	
12	1575A	177X	111	Loss
	1575H	1575X	152	
20	9849D	1575A	46	Loss
	671J	1575Z	37	
28	1575V	1575C	75	Win
	1575A	671E	45	
38	180	1575A	89	Win
	12Z	1003E	90	
42	1575A	12C	117	Win
	12B	671C	98	
Average			83.5	

Continued to page 1-208

SIGNATURE

DATE

DISCLOSED TO AND UNDERSTOOD BY

DATE

PROPRIETARY INFORMATION

ai

11/23/15

11/23/15

Statistics for Woodrow Wilson High School Competition (cont.)

11/23/15

Quarterfinals

Match Number	Red Alliance	Blue Alliance	Scores	Win/Loss for 1575A
1-2	3623A	671D	182	Win
	1575A	1575B	97	
Average			182	

Semifinals

Match Number	Red Alliance	Blue Alliance	Scores	Win/Loss for 1575A
1-2	3623A	1575D	166	Win
	1575A	1575H	73	
Average			166	

Finals

Match Number	Red Alliance	Blue Alliance	Scores	Win/Loss for 1575A
1-1	3623A	177X	190	Loss
	1575A	12B	192	
Average			190	

Average Performance for Each Match: 115.4

Average Performance for Qualification Matches: 83.5

Average Performance for Elimination Matches: 179.3

* We realized that the statistics shown on pg. 1-165 are inaccurate. The charts on pg. 1-63 to 1-65 are calculated correctly, but the "Average Performance at the Competition" number skews the average of the overall

Continued to page 1-209

SIGNATURE

11 -

DATE

11/23/15

DISCLOSED TO AND UNDERSTOOD BY

Ac

DATE

11/23/15

PROPRIETARY INFORMATION

Statistics for Woodrow Wilson High School Competition (cont)

11/23/15

competition; it weighs the stages of the competition (eliminations, quarterfinals, etc.) the same, even though the later stages have less than two matches or less, while the ^{qualification} ~~elimination~~ matches have more than five at a typical competition. As a result, we now calculate the average of the qualification matches and elimination matches separately. This allows us to see how we improved from early on in the competition to the final match. To see the revised statistics for the Potomac High School Competition, see the reflections section in the binder.

- The average score for each match improved by approximately 7 points. However, our average score for qualification matches decreased by the same amount. However, our average for the elimination matches increased by about 36 points. This may have been because we were allied with the first seed alliance, but we also were able to improve throughout the competition, which made the score difference much greater.

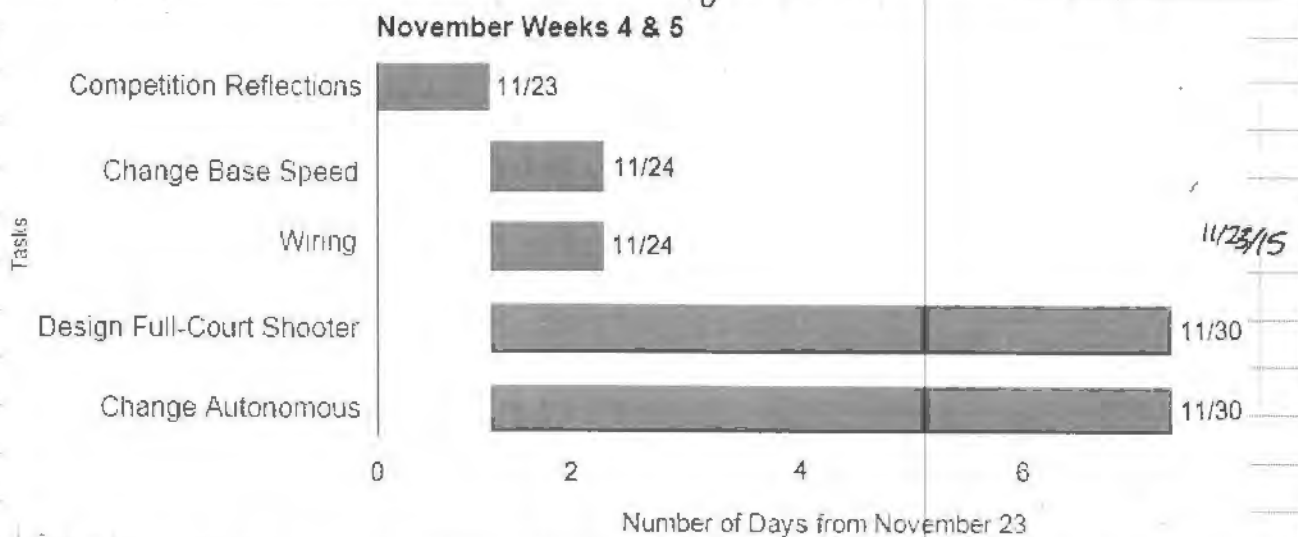

- We will change the base and rewire at the start of the two weeks, then begin creating a full-court shooter and a new autonomous skills program.

Continued to page

SIGNATURE

DATE

11/23/15

DISCLOSED TO AND UNDERSTOOD BY

DATE

11/23/15

PROPRIETARY INFORMATION

Build Day 47 / Project WELP Day 1

11/24/15

- Objectives for Today
 - Rewire Robot
 - Switch Wheels on Base
 - Begin Project WELP
- Today we changed the 3.25" omni-wheels to 4" omni-wheels to increase the speed of the base. In order to fit the wheels, we had to move the location of the quad encoders. However, within 5 seconds, the motors stalled. This occurred continuously after many attempts to drive. The stalling most likely occurred, because the high speed gear ratio ^{A.A.} ~~was~~ ^{too} ~~high~~ caused too much stress on the motors. We changed the base back to its original state at the start of the meeting.
- We were also able to rewire the entire robot so that all of the ports were easily accessible.
- * Today the Woodbridge Elastic Longrange-Shooter Program (WELP) began. For this project, we are collaborating with teams 1575B and 1575X to prototype and test a full-court shooter that is compatible with all of our robots. We are implementing the design process flow chart taught in the engineering program Project Lead the Way (PLTW) to create a general schedule that can be easily followed by all 3 teams. The flow chart is shown on pg. 1-216, and the gantt chart is shown on pg. 1-215.
- Define Problem (Project WELP Step 1)
 - To start, we discussed requirements for the shooter's design.
 - We need a shooter that can shoot from the alliance tik into the high goal on the opposite side of the field. We will construct an elastic shooter, because it has the capability to shoot full-court, cost-effectiveness, and the ability to fit within a small space.

Continued to page 1-211

SIGNATURE

DATE

DISCLOSED TO AND UNDERSTOOD BY

DATE

PROPRIETARY INFORMATION

Build Day 47/Project WELP Day 1 (cont.)

11/24/15

- Because of the time constraint (2 weeks), the design must be easily built ^{is} in a short amount of time.
- The shooter must be compatible with the robot's current design; the teams should not have to modify their original mechanisms to encompass the shooter.
- The shooter should require only 2 motors. This allows for more flexibility with the other subsystems' designs.
- The shooter must be very efficient. It should be able to shoot ^{at} at least one ball every 2 seconds.
- Generate Concepts (Project WELP Step 2)
- Next, we brainstormed specific elastic shooter designs and discussed which design was most suitable for our robots. The decision matrix shown below was utilized to determine which design would have the highest value for our robots.
- Project WELP Decision Matrix (scored on a 1-10 scale, with 10 being the highest possible score)

	Speed	Compatibility	Ease of Build	Accuracy
Frictionless Slide	9 • The shooter fires at an extremely quick speed, about 2 balls per second.	8 • It is a very simple, modular design that can easily attach to any of the existing robots.	7 • It would be extremely easy to build, because it would only take about 1 hour to design, and our team has built a mechanism similar to this (shown on pg. 1-40 & 44).	7 • It has about a 70% accuracy rate, which is inconsistent compared to the cam gear shooter.
Total Points:				
31				

Continued to page 1-212

SIGNATURE

DATE

11/24/15

DISCLOSED TO AND UNDERSTOOD BY

DATE

11/24/15

PROPRIETARY INFORMATION

Build Day 47/Project WELP Day 1 (cont.)

11/24/15

• Project WELP Decision Matrix (cont.)

	Speed	Compatibility	Ease of Build	Accuracy
<u>Cam Gear Shooter</u> Total Points: 26	6 • Although it is slow compared to the frictionless slide and slip gear shooter, it can still shoot about 1 ball every 2 seconds.	5 • Because it would take up a lot of space, the teams would have to modify their current design to use it.	6.5 • Due to the lack of parts (ex. cam gears), this would take more time to build. However, it would be simple to build it otherwise, because we currently have a functioning short-range cam gear shooter.	8.5 • It ^{is} has about an 85-90% accuracy rate, which is consistent compared to the frictionless slide and slip gear shooter.
<u>Slip Gear Shooter</u> Total Points: 28	8 • Its speed is slightly slower than the frictionless slide.	7 • Like the frictionless slide, the slip gear shooter is a simple, modular design that can easily attach to any of the existing robots. However, it expands more than the former.	6 • Except for the cutting and polishing of the slip gear, the shooter would be fairly easy to build.	7 • It has about a 70% accuracy rate, which is inconsistent compared to the cam gear shooter.

- The frictionless slide design was chosen because of its high compatibility with each of our robots and its fast firing rate.

Continued to page 1-213

SIGNATURE

[Signature]

DATE

11/24/15

DISCLOSED TO AND UNDERSTOOD BY

[Signature]

DATE

11/24/15

PROPRIETARY INFORMATION

Build Day 47/Project WELP Day 1 (cont.)

11/24/15

- After deciding on a design, we created a rough sketch.
- Project WELP ^{A.A.} (~~Top View~~) Shooter (Top View)

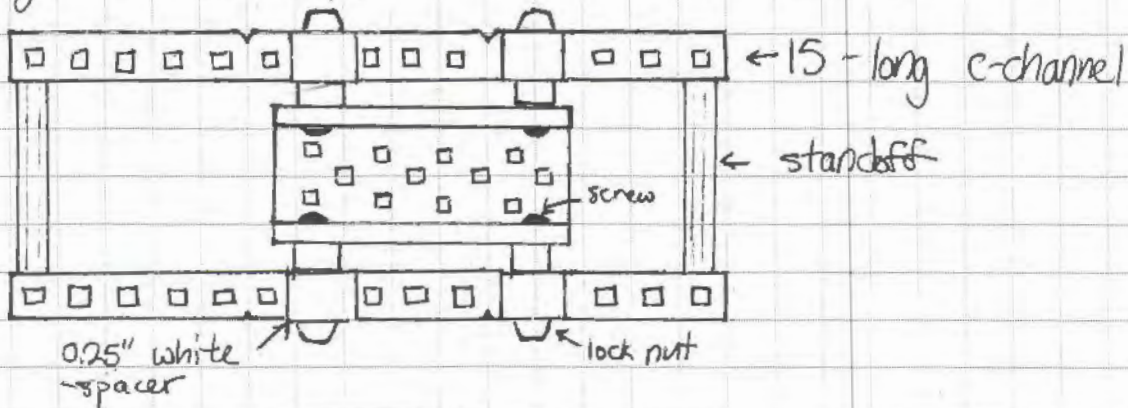

- Project WELP Shooter (Front View)

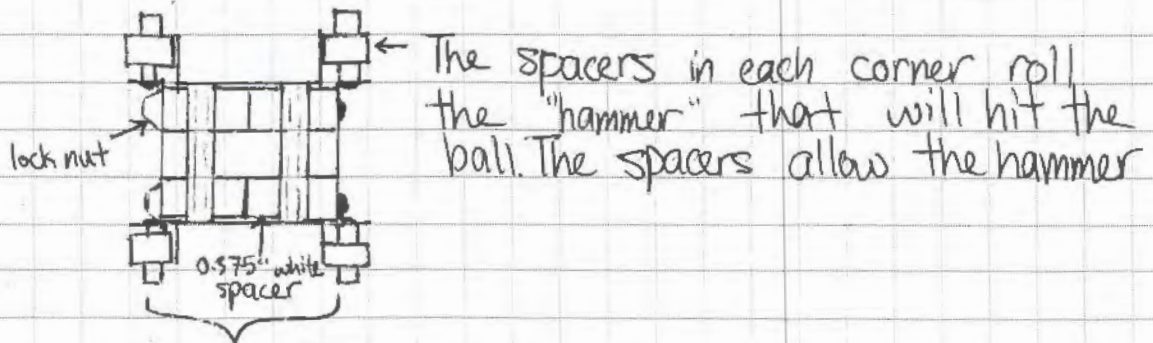

This row of spacers prevents the hammer from falling out by hitting the standoffs.

- Develop a Solution
- After creating the sketches, we CADed the designs^{A.A.} so that we could find the optimal spacing for the shooter. The CADs are shown on the following page.

new 11/24/15

Continued to page | -214

SIGNATURE

DATE

11/24/15

DISCLOSED TO AND UNDERSTOOD BY

DATE

11/24/15

PROPRIETARY INFORMATION

h1

Project WELP Frictionless Slide CADs

11/24/15

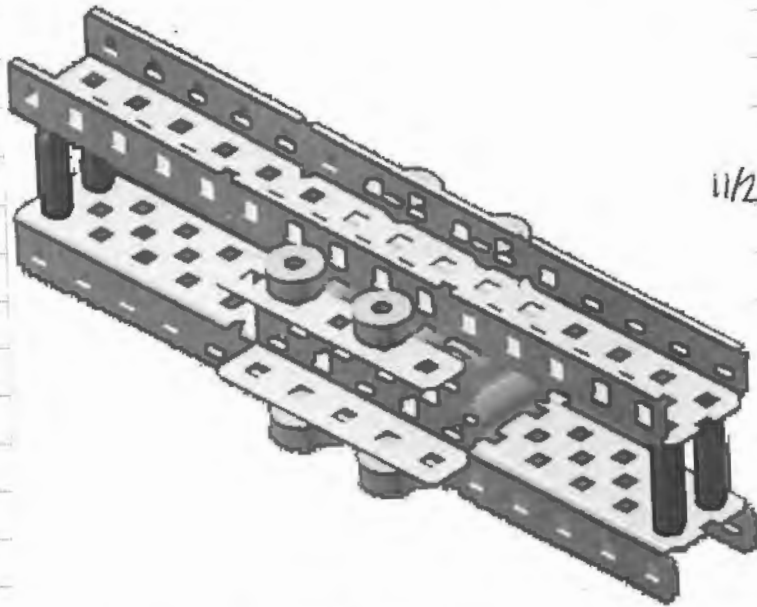

Frictionless Slide (Isometric View)

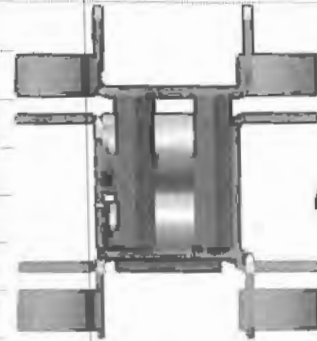

Frictionless Slide (Front View)

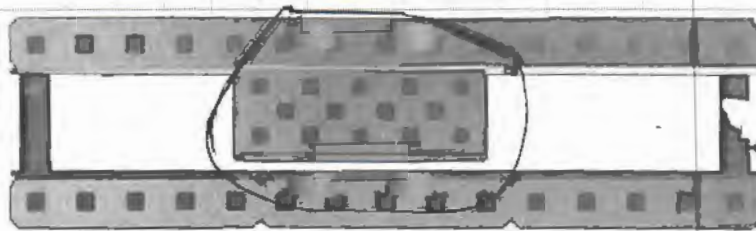

Frictionless Slide (Top View)

- The Isometric View CAD displays a clear view of the spacers within the shooter's frame.
- The Top View CAD displays a clear view of the spacers that allow for smooth shooting, circled above.

• Next Time
 - Continue Project WELP

Continued to page 1-215

SIGNATURE

[Handwritten Signature]

DATE

11/24/15

DISCLOSED TO AND UNDERSTOOD BY

[Handwritten Signature]

DATE

11/24/15

PROPRIETARY INFORMATION

Build Day 47/Project WELP Day 1 (cont.) 11/24/15



Modifying the Box

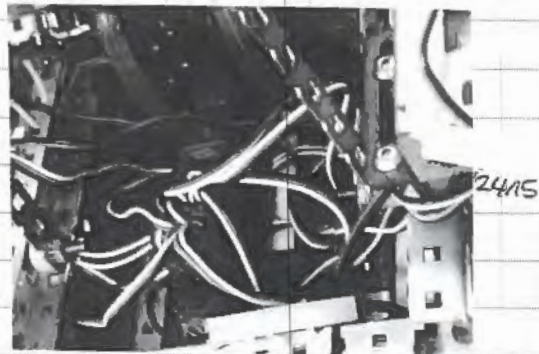

Rewiring



After rewiring, we had a large pile of zip ties that were cut!

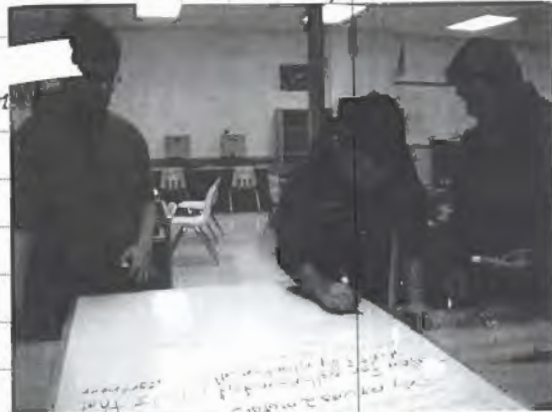

Discussing Design Constraints

Project WELP

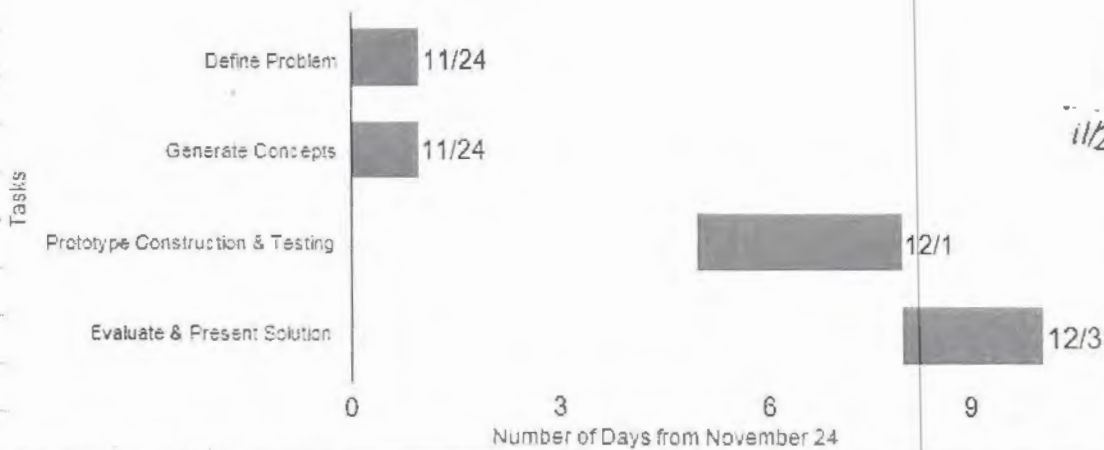

11/24/15

• Later this week, we will begin prototype construct and testing, and evaluate and present our solution (the design)

Continued to page 1-216

SIGNATURE

DATE

11/24/15

DISCLOSED TO AND UNDERSTOOD BY

DATE

11/24/15

PROPRIETARY INFORMATION

Build Day 47/ Project WELP Day 1 (cont.)

11/24/15

for the full court shooter), which are steps 3-6 in the PLTW Design Process Flow Chart, shown below.

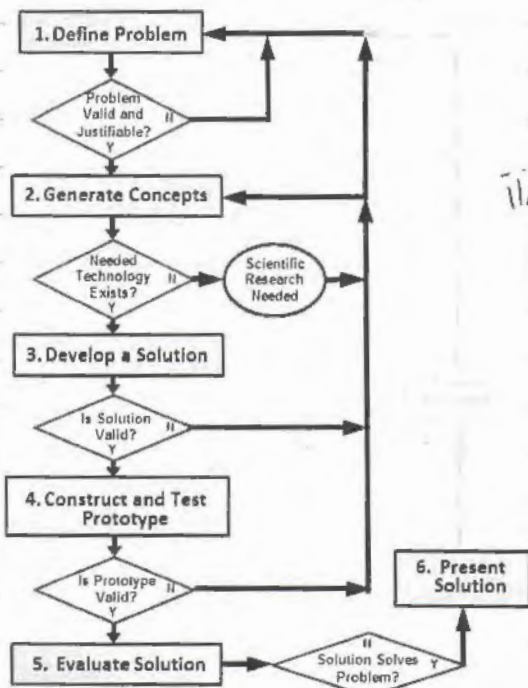

11/24/15

Today, we were able to complete Steps 1-3. However, we may return to Steps 2 and 3 if the initial design does not perform well.

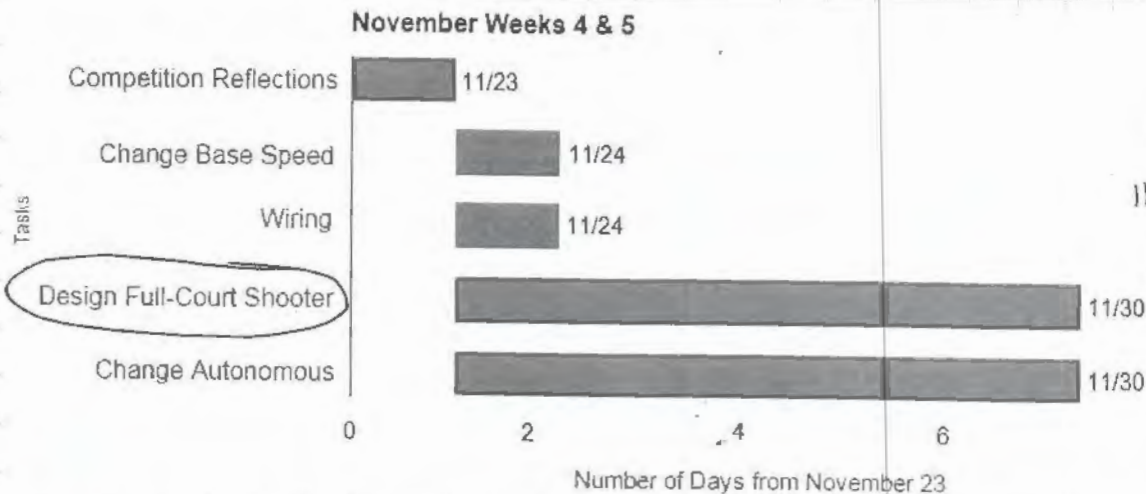

11/24/15

The "Design Full-Court Shooter" task represents project WELP, circled above. Project WELP's Gantt Chart is shown on pg. 1-215 215.

Continued to page

SIGNATURE

[Handwritten Signature]

DATE

11/24/15

DISCLOSED TO AND UNDERSTOOD BY

[Handwritten Initials]

DATE

11/24/15

PROPRIETARY INFORMATION

Build Day 48 / Project WELP Day 2

11/30/15

- Objectives for Today
 - Continue Project WELP (Build Frictionless Slide)
- Today we began Step 4 of the PLTW Design Process, Construct and Test Prototype (shown on pg. 1-216).
 - ~~First, we cut $\frac{1}{4}$ of the total number of ^{A.A.} teeth on the 36-tooth gear (9 teeth).~~
 - First, we began building the shooter's frame. After we built the frame, we completed the inner roller (shown on pg. 1-214).
 - Next, we added cam gears and 1 motor, so that we could attempt to power the shooter with the lowest amount of power. However, it was not able to shoot full court, and if we decided to attach another motor, it would be too wide to fit on our robots. As a result, we decided that the frictionless slide design was incompatible with our robots, and not a worthwhile design to pursue. We will need to decide on a new design next meeting.
- Next Time
 - Continue Project WELP (Return to PLTW Design Process Step 2 (Generate Concepts))

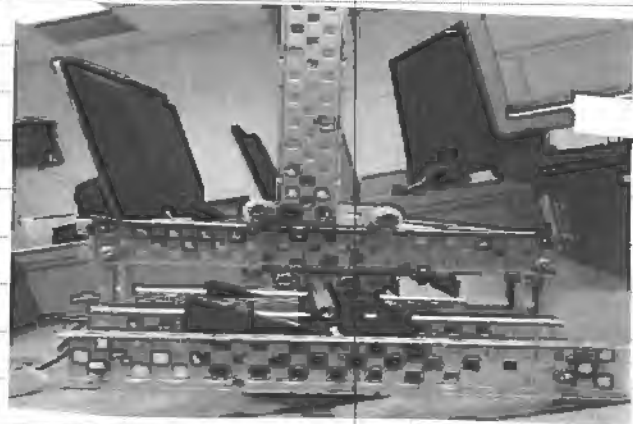

and (From 1575B and 1575A respectively) working on the Frictionless Slide

Frictionless Slide Design
(Side View)

SIGNATURE

DATE

Continued to page

11/30/15

DISCLOSED TO AND UNDERSTOOD BY

DATE

PROPRIETARY INFORMATION

11/30/15

December Schedule

12/1/15

December 2015

12/1/15

Sun	Mon	Tue	Wed	Thu	Fri	Sat
		1 Finish Project WELP Steps 3 & 3 Holy Family Mentoring	2 Begin Project WELP Step 4 Improve Autonomous Begin Redesigning Robot for States	3 Finish Project WELP (All Steps) Efficiency Testing Holy Family Mentoring	4 Presentation Practice	5 Woodbridge Senior High School Tournament
6	7 Post-Competition Reflection	8 Fix Problems From Previous Competitions	9 Fix Problems From Previous Competitions	10 Fix Problems From Previous Competitions	11 Fix Problems From Previous Competitions	12
13	14 Continue Redesigning Robot for States	15 Continue Redesigning Robot for States	16 Continue Redesigning Robot for States	17 Continue Redesigning Robot for States	18 Continue Redesigning Robot for States Efficiency Testing	19
20	21 Winter Break	22 Winter Break	23 Winter Break	24 Winter Break	25 Winter Break	26
27	28 Winter Break	29 Winter Break	30 Winter Break	31 Winter Break AA (201)		

December Schedule

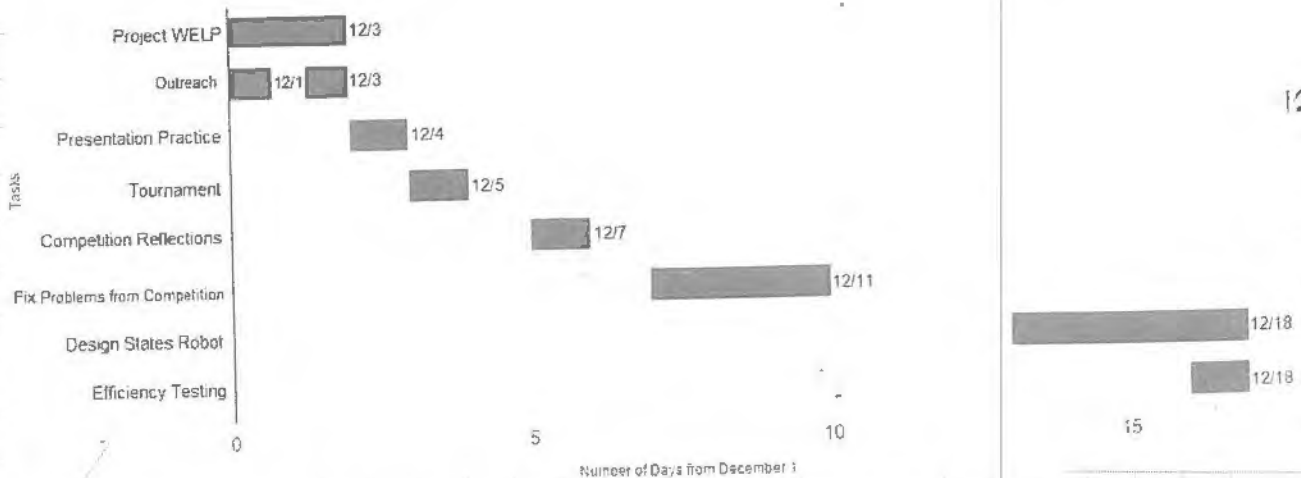

12/1/15

- We will work on Project WELP (see pg. 1-215), preparing for the tournament, competing, then reflecting. Then, we will begin designing our robot for states and do efficiency testing for the new robot.

Continued to page

SIGNATURE

[Handwritten Signature]

DATE

12/1/15

DISCLOSED TO AND UNDERSTOOD BY

[Handwritten Initials]

DATE

12/1/15

PROPRIETARY INFORMATION

Project WELP Day 3

12/1/15

- Objective for Today
 - Continue Project WELP (Return to PLTW Design Process Step #^{A.A.} 2 (Generate Concepts))
- First, we referred back to our ^{A.A.} design decision matrix (shown on pg. 1-211 and 212). We decided to choose the slip gear shooter design (with the second highest value in the decision matrix), because of its high speed and compatibility.
- During this Generate Concepts phase, we decided to research different slip gear designs. We came across a very fast slip gear shooter made by team 22. To receive a professional, experienced opinion, we contacted the VEX U team at George Mason University, which contains many VRC-experienced members. Together, we discussed the advantages and disadvantages of 22's design (shown on pg. 1-).
- We then created a sketch of a design that would be able to fit our constraints, shown below.

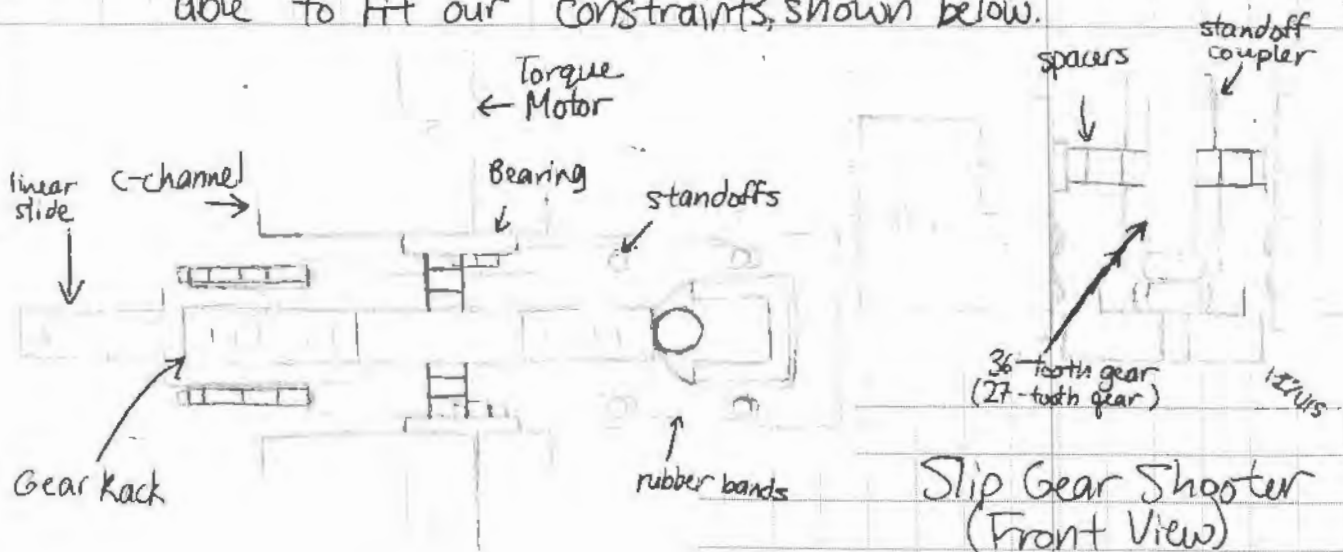

12/1/15
Slip Gear Shooter (Top View)

Slip Gear Shooter (Front View)

Continued to page 1-226

SIGNATURE

DATE

DISCLOSED TO AND UNDERSTOOD BY

DATE

PROPRIETARY INFORMATION

Project WELD Day 3 (cont.)

12/1/15

- In the sketches shown on the previous page, the gear is labeled as a 36-tooth gear and a ^{AA} 27-tooth gear in parentheses. This is because 9 teeth must be cut off of a 36-tooth gear to allow the gear to lose contact with the slide that has the hammer and shoot.
- Develop a Solution (Step 3)
- After creating the sketches, we CADed the design to find the optimal spacing for the shooter. The CADs are shown below and on the following page.

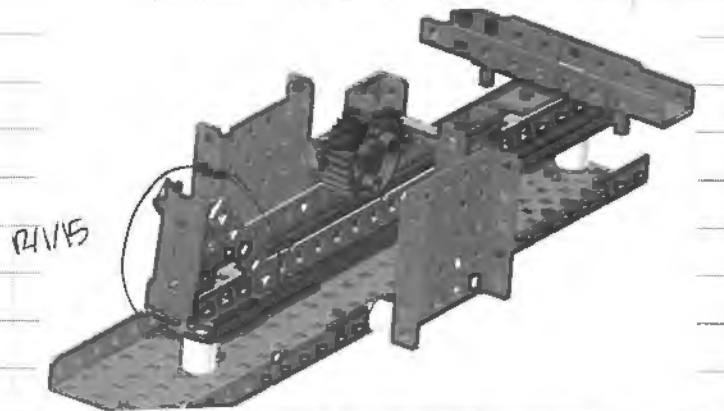

Slip Gear Shooter (Isometric View)

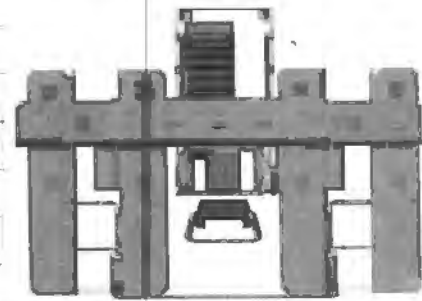

Slip Gear Shooter (Front View)

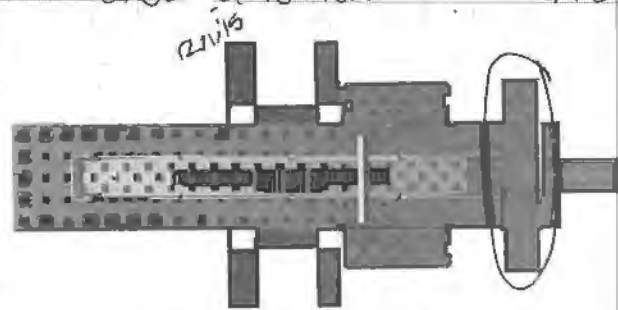

Slip Gear Shooter (Top View)

- Notice the the slightly tilted standoff coupler circled in the Isometric View CAD. The angle allows the ball to be shot slightly higher than if it was directly upright on the c-channel. Although the standoff coupler is more solid and sturdier than a normal ^{AA} c-channel (because it has less holes, we decided to attach a truss

Continued to page 1-221

SIGNATURE

[Handwritten signature]

DATE

12/1/15

DISCLOSED TO AND UNDERSTOOD BY

[Handwritten initials]

DATE

12/1/15

PROPRIETARY INFORMATION

Project WELP Day 3 (cont.)

12/1/15

not only prevents the coupler from rotating, but also braces it for the fast acceleration of the shooter.

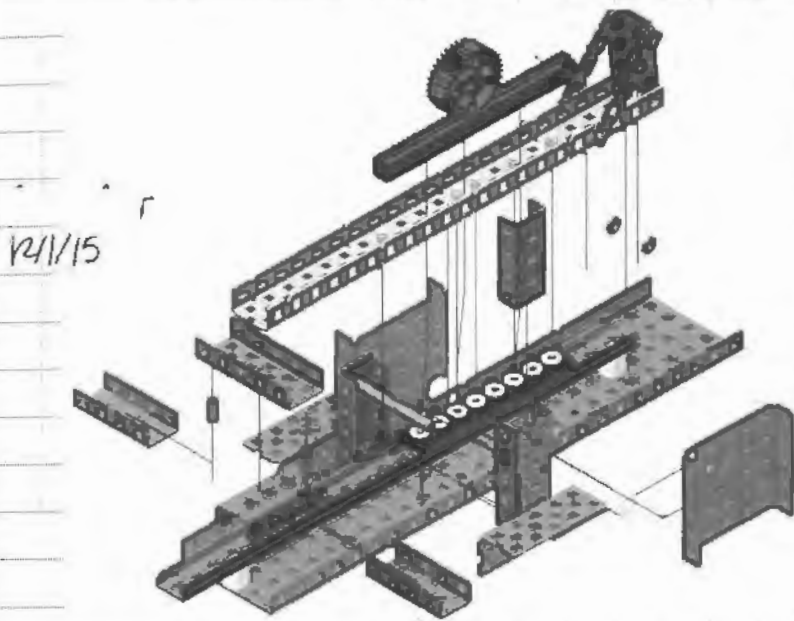

Because the shooter contains many small components, we separated the parts to clearly see each component's position in the assembly.

A.A. ~~Next Time~~ A.A.

9. Prototype Construction and Testing (Step 4)

- First, we began by creating the slip gears. The 9 teeth were cut off with a drummel, then were polished to give a smooth finish. This not only creates an aesthetically-pleasing image, but also prevents the slip gear from getting inadvertently stuck on the gear rack.
- Next, we began constructing the slip gear shooter itself. We were able to finish the linear slide's mount. We will continue building tomorrow.

• Next Time

- Continue Project WELP (Return to Step 4 (Construct & Test Prototype))
- Refine Autonomous
- Begin Designing Transmission Base

Continued to page 1-222

SIGNATURE

DATE

12/1/15

DISCLOSED TO AND UNDERSTOOD BY

DATE

12/1/15

PROPRIETARY INFORMATION

Project WELP Day 3 (cont.)

12/1/15

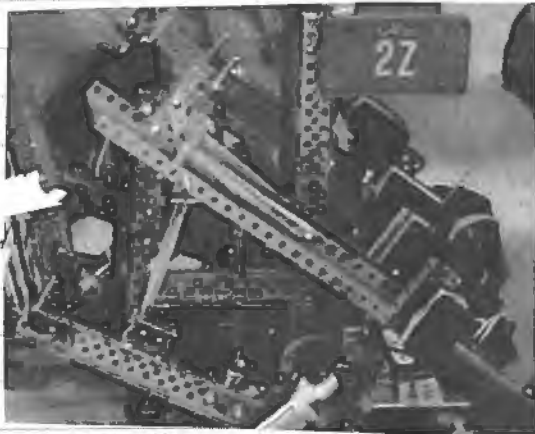

22's Slip Gear Shooter



Cutting and Polishing the Gears

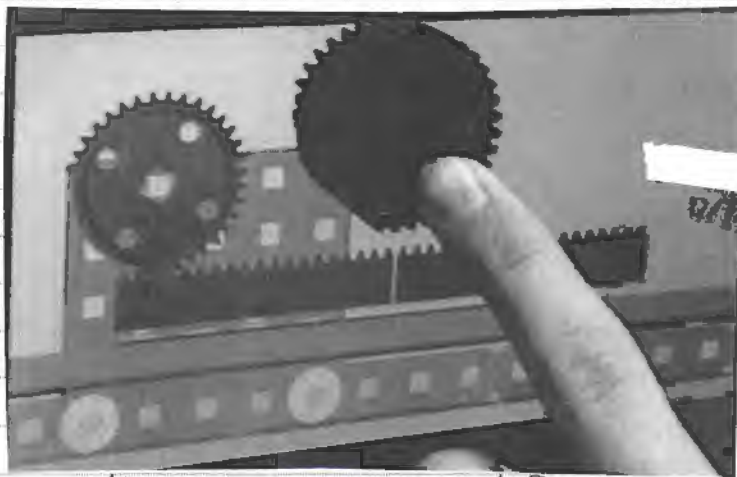

Slip Gear : Finished Product



Building the WELP Prototype

December Week 1

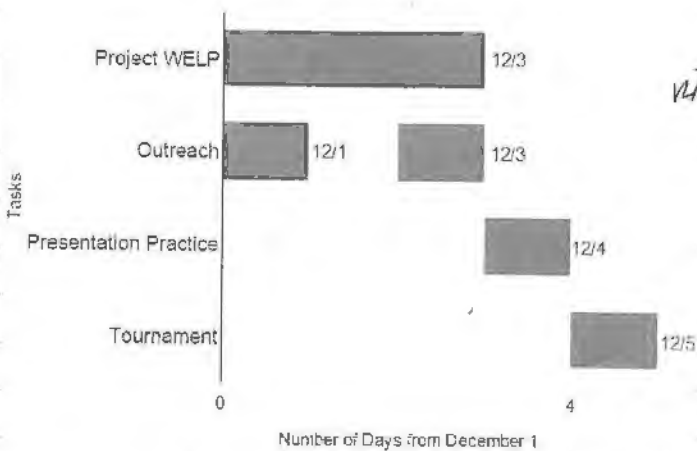

12/1/15

- Throughout the week, we will work on Project WELP (see pg. 1-215 for full breakdown), presentation, and doing well at the tournament at the end of the week.

Continued to page

SIGNATURE

[Signature]

DATE

12/1/15

DISCLOSED TO AND UNDERSTOOD BY

[Signature]

DATE

12/1/15

PROPRIETARY INFORMATION

Project WELP Day 5 / Programming Day 25 / Build Day 49

12/3/15

- Objectives for Today
 - Present Solution (Final Step of Project WELP)
 - Efficiency Testing
- Present Solution (Final Step of Project WELP)
 - After completing the prototype and testing it, team 1575X was given the shooter. Each team began constructing and modifying their own shooters independently, trying to make their shooter as efficient as possible. This marks the end of the project.
 - While constructing the shooter, one member forgot to attach the c-channel between the screw and lock nut. They removed the lock nut and placed the c-channel in its correct position. We were then able to complete the entire shooter.
 - Later, we began testing the shooter. However, it only shot approximately 6 feet across, even when add more rubber bands for tension. We realized that we did not place enough washers between the hammer's c-channel and the 5-wide c-channel. After adding washers, the shooter could fire much further.
 - After adjusting the number of rubber bands so that the shooter could fire into the high goal, we tested the full-court shooter's efficiency. The team had 10 loads outside of the field, while the robot was in the loading zone. One member would hold down the shooting button, while another member would place the balls on the robot. The results are shown on the following page.
 - For the slip gear shooter, V splitters were used for the ports ~~AAA~~ for the bar shooter. This is because only one shooter can be used at a time (they shoot at different distances), so the motor stress is only from one mechanism.
- Next Time
 - Efficiency Testing

SIGNATURE

M

M . . .

DATE

12/3/15

Continued to page 1-227

DISCLOSED TO AND UNDERSTOOD BY

M

DATE

12/3/15

PROPRIETARY INFORMATION

Project WELP Day 5/Programming Day 25/Build Day 4 (cont.)

12/3/15

Shooting Balls into High Goal

Trial	Number of Balls that Reached High Goal	Total Time (in Seconds)
1	10/10	12.31
2	8/10	12.89
3	7/10	11.14
4	7/10	11.27
5	10/10	12.09
6	9/10	11.55

- Calculations for Average Number of Balls that Reached High Goal (Accuracy Rate)

$$\bar{x} = \frac{\text{the sum of the number of balls that made it into the high goal}}{\text{the total number of balls shot}}$$

$$= \frac{10+8+7+7+10+9}{10 \cdot 6} = \frac{51}{60} = 0.85 \quad \boxed{85\% \text{ Accuracy Rate}}$$

To find the average number of balls shot into the high goal for each trial, the accuracy rate was multiplied by the number of balls shot in each trial. $0.85 \cdot 10 = 8.5$

For every 10 balls, about 9 will reach the high goal.

- Calculations for Average Total Time

$$\bar{x} = \frac{\text{the sum of the total number of seconds for all trials}}{\text{number of trials}}$$

$$= \frac{12.31+12.89+11.14+11.27+12.09+11.55}{6} = \frac{71.25}{6} = \boxed{11.875 \text{ seconds}}$$



Forgetting to Attach the C-channel



We didn't have the proper spacing below the hammer, causing instability.

Continued to page 1-228

SIGNATURE

DATE

12/3/15

DISCLOSED TO AND UNDERSTOOD BY

DATE

12/3/15

PROPRIETARY INFORMATION

Project WELP Day 5 / Programming Day 25 / Build Day 49 (cont.) 12/3/15



12/3/15

Attaching Motors

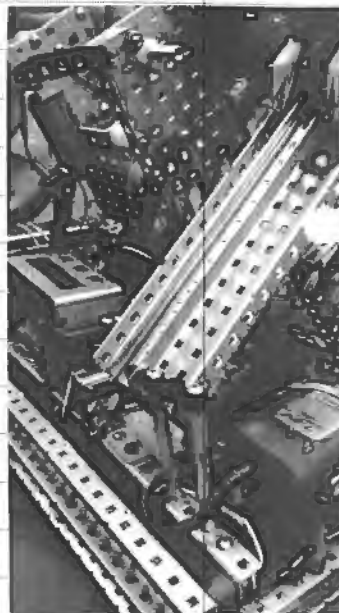

12/3/15

Slip Gear Shooter Mount

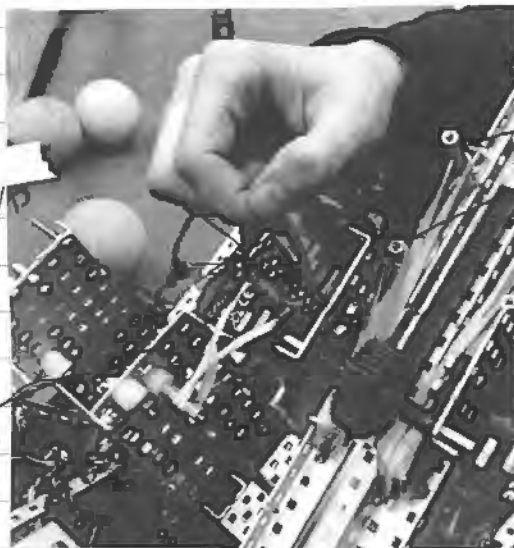

12/3/15

This rubber band adds support to the motor for the continuous shooting.

The rubber bands are wrapped around standoffs at different distances so that the ^{A.A.} tension can be changed in smaller increments. This will especially assist us at the competition, when the tension will slowly be worn down.

12/3/15

SIGNATURE

[Handwritten signature]

Continued to page

DATE

12/3/15

DISCLOSED TO AND UNDERSTOOD BY

[Handwritten signature]

DATE

12/3/15

PROPRIETARY INFORMATION

Build Day 5012/4/15

- Objective for Today
 - Efficiency Testing for Full-Court Shooter
- At first, we were going to start efficiency testing, but the shooter would not function correctly. We realized that the motorcontroller's^{AA} and motor on the full-court shooter were very hot. After replacing the motorcontroller, the shooter could function correctly.
- Next we tested efficiency as planned, using the set-up described under the 6th bullet on pg. 1-226. The results are shown below.

Shooting Balls into High Goal		
Trial	Number of Balls that Reached High Goal	Total Time (in Seconds)
1	9/10	8.43
2	9/10	8.72
3	8/10	8.50

- Calculations (see pg. 1-227 for general equations)

Accuracy Rate: $\frac{9+9+8}{10+10+10} = \frac{26}{30} = 87\%$ Accuracy Rate

For every 10 balls, about $(0.87 \cdot 10 = 8.7)$ nine balls will be shot into the high goal.

Average Total Time: $\frac{8.43+8.72+8.5}{3} = 8.55$ seconds

- Next Time
 - Do Well at the Competition!!!

M. J. - 12/4/15

Continued to page | -230

SIGNATURE

DISCLOSED TO AND UNDERSTOOD BY

DATE

DATE

PROPRIETARY INFORMATION

Build Day 50 (cont.)

12/4/15

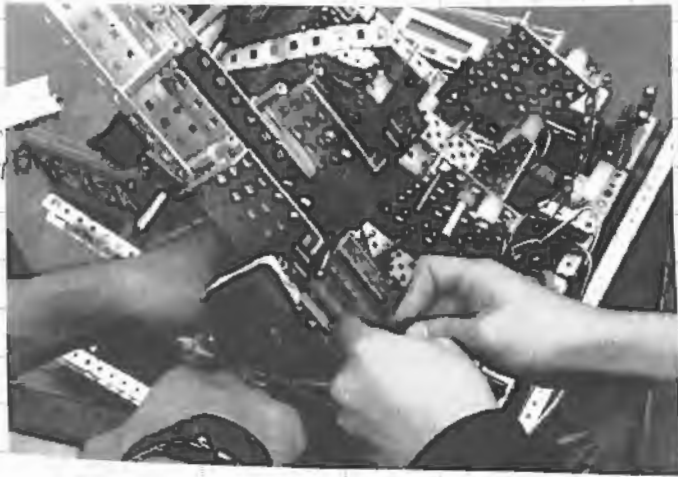

Preparing for Efficiency Testing



The Replaced Motor



The mesh prevents external damage to the shooter. This is especially important because of the shooter's temperamental nature. It also prevents the shooter from being revealed too early in the season, eliminating ~~it~~ our edge.

After many tests, the robot is ready for competing!

SIGNATURE

DATE

Continued to page

DISCLOSED TO AND UNDERSTOOD BY

DATE

12/4/15

12/4/15

PROPRIETARY INFORMATION

December 5th, 2015: Woodbridge Senior

High School Competition

12/5/15

- Objective for Today
 - Do Well at the Competition!!!
- During our first match, the intake fell out of its correct position, because its axle came out of the bearing. After retightening the collar on the axle, the intake functioned correctly. During this match, the mesh on the WELP shooter came loose and dragged on the field. The base got caught on the mesh, causing the motors to stall. Furthermore, the WELP shooter also could not function. After this match, we tested the WELP shooter's motor and realized it was broken. We replaced the motor and carefully ziptied the mesh around the WELP shooter. Both problems were resolved from these actions.
- In our third match, our robot swerved into the opposing alliance's climbing zone during autonomous and was disabled. After the motors were tightened and an axle was placed back into its corresponding motor^s, the swerving was fixed.
- Throughout the competition, the base would cease to move at approximately 30 seconds left during driver control period. Because of the time constraint that prevented us from redesigning our base, we decided to ensure we could reach our climbing zone before that time and shoot balls full-court instead. The base motors were most likely over-stressed by the high speed gear ratio (5:1). We will fix the mechanical issue some time ~~this~~^{next} week.
- Next Time
 - Post-Competition Reflection

Continued to page 1-232

SIGNATURE



DATE

12/5/15

DISCLOSED TO AND UNDERSTOOD BY



DATE

12/5/15

PROPRIETARY INFORMATION

December 5th, 2015: Woodbridge Senior High School Competition (cont.)

12/5/15



12/5/15



12/5/15



12/5/15



12/5/15



12/5/15

Qualification Rankings
BY SCHOOL

1175A	Amiga	3	62	2-0-0
1175B	Don Steaks	4	66	2-0-0
1175C	Sandy's	1	61	2-0-0

Bill Miller
12/5/15



12/5/15



12/5/15



12/5/15



12/5/15

Continued to page 1-233

SIGNATURE *TJ Miller*

DATE
12/5/15

DISCLOSED TO AND UNDERSTOOD BY
si

DATE
12/5/15

PROPRIETARY INFORMATION

December 5th, 2015: Woodbridge Senior High School Competition (cont.)

12/5/15



12/5/15

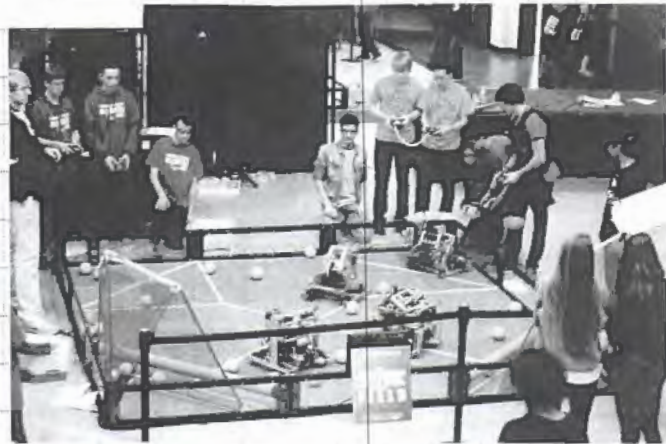

12/5/15



12/5/15

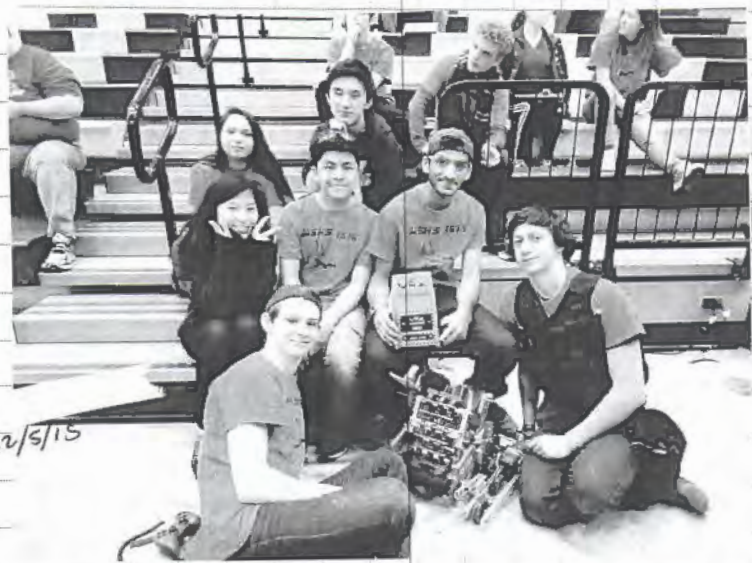

12/5/15



12/5/15



12/5/15

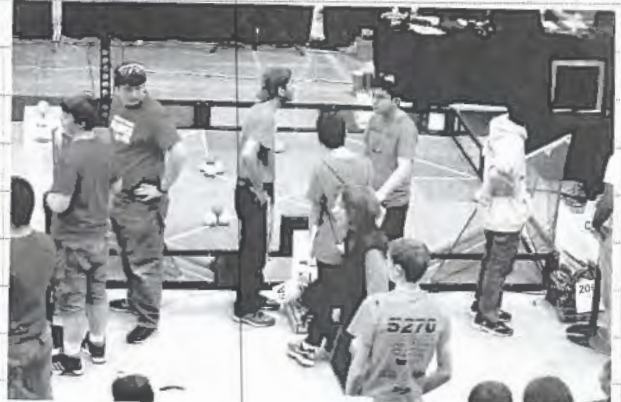

12/5/15

Continued to page

SIGNATURE

DATE

12/5/15

DISCLOSED TO AND UNDERSTOOD BY

DATE

12/5/15

PROPRIETARY INFORMATION

lv

December 7, 2015: Post-Competition Reflection

12/7/15

• Personal Statements

- "I think it was an overall okay competition since we managed to have a consistent and reliable autonomous. It allowed us the capability to do well, but our execution to do so was lacking."
- "The robot's program was fairly consistent throughout the day, but due to many problems, we did poorly overall."
- "If we were to have more consistent, reliable motors, our robot could have done a lot better."
- "I believe we were well prepared for the day, but due to small errors, we weren't able to do as well as we could have."
- "The day was overall successful in that we learned what we needed and didn't need to improve our robot and strategy. I believe we did well early on in the day, but stumbled at minor difficulties towards the end- although they were nothing we aren't able to fix for next time."
- "The competition went well, but the WELP shooter's precision was low."
- "Although we were disabled during one match, we were able to score quickly in the other matches."
- **Post-Competition Reflection**
 - There were some aspects of the robot that performed well during the competition.
 - When the broken motor on the WELP was replaced, the shooter was able to fire into the high goal. This allowed us to have a solid back-up plan when the base died.
 - Our driver's control of the robot improved from the previous competition.

Continued to page 1-235

SIGNATURE _____

DATE

12/7/15

DISCLOSED TO AND UNDERSTOOD BY

DATE

12/7/15

PROPRIETARY INFORMATION

December 7, 2015: Post-Competition Reflection (cont.)

12/7/15

- The base was very fast, because its 5:1 gear ratio could allow it to move quickly.
- The autonomous program was very consistent throughout the competition; ~~in fact~~, in fact, the autonomous's success in the first match allowed us to win the match.
- The rubber bands only needed to be switched once during the competition. This slightly lowers the cost of the robot.
- However, some aspects of the robot performed poorly.
 - The robot's consistency was low throughout the competition. The mesh and the axle fell out of its correct position, and some of the motors malfunctioned.
 - The base always stopped when there was approximately 30 seconds remaining during matches.
 - The arch above the WELP shooter came loose during the elimination matches, causing the one-by to interfere with the shooter's accuracy.
 - The drivers still have a problem intaking balls on the field, because 2 balls being intaken would cause the intake to jam (see pg. 1-205).
- We will ~~improve~~ ^{address} the problems observed at the competition by completing the following tasks.
 - First, we will fix the stalling issue with the base motors. We will do this by lessening the gear ratio (5:1) to 3:1. Although the base's speed will be slower, its reliability will increase.
 - We will also refine the design of the intake, a problem from the previous competition (see pg. 1-205) so that we will be able to gather balls efficiently.
 - We will also construct a high elevation mechanism so that the robot can score 50 points quickly.
- * In order to create a robot that can compete on an international level, we will have 2 long-range shooters and 1 short-range shooter.

Continued to page 1-236

SIGNATURE

DATE

12/7/15

DISCLOSED TO AND UNDERSTOOD BY

DATE

12/7/15

PROPRIETARY INFORMATION

December 7, 2015: Post-Competition Reflection (cont.)

12/7/15

- Because we require more motors for the shooter, ~~and~~ we are making a transmission that can power either the base or the full-court shooters.
- We will refine the WELP shooter so that its precision is higher.

12/7/15

Continued to page

SIGNATURE

[Signature]

DATE

12/7/15

DISCLOSED TO AND UNDERSTOOD BY

[Signature]

DATE

12/7/15

PROPRIETARY INFORMATION

Statistics for Woodbridge Senior High School Competition (cont.)

12/7/15

Competition at Woodbridge Senior High School

Rank: 12

Wins - Losses - Ties: 4-1-0

Win Points / Score Points: (8/152)

12/7/15

Qualification Matches

Match Number	Red Alliance	Blue Alliance	Scores	Win/Loss for 1575A
6	5575M	6603B	18	Win
	4303A	1575A	39	
17	8044	1575C	173	Win
	1575A	1575R	64	
32	4343C	8994	17	Loss
	1575A	4303X	76	
59	2068G	1575A	33	Win
	4303B	12A	85	
67	5575Z	1575A	20	Win
	2068W	2068F	127	
Average			88.2	

12/7/15

Continued to page 1-238

SIGNATURE

DATE

DISCLOSED TO AND UNDERSTOOD BY

DATE

PROPRIETARY INFORMATION

AW

12/7/15

12/7/15

Statistics for Woodbridge Senior High School Competition (cont.)

12/7/15

Quarterfinals

Match Number	Red Alliance	Blue Alliance	Scores	Win/Loss for 1575A
4-1	12E	1575B	132	Win
	4303C	1575A	153	
4-2	4303C	1575A	202	Loss
	12B	5270Y	70	
Average			111.5	

Average Performance for Each Match: 94.9
 Average Performance for Qualification Matches: 88.2
 Average Performance for Elimination Matches: 111.5

12/7/15

The average score for each match decreased by about 21 points. However, the average score for qualification matches increased by 4.5 points. The average score for each elimination match decreased by 68 points. This overall decrease in performance was most likely caused by the base shutting down and the match where the robot was disabled.

12/7/15

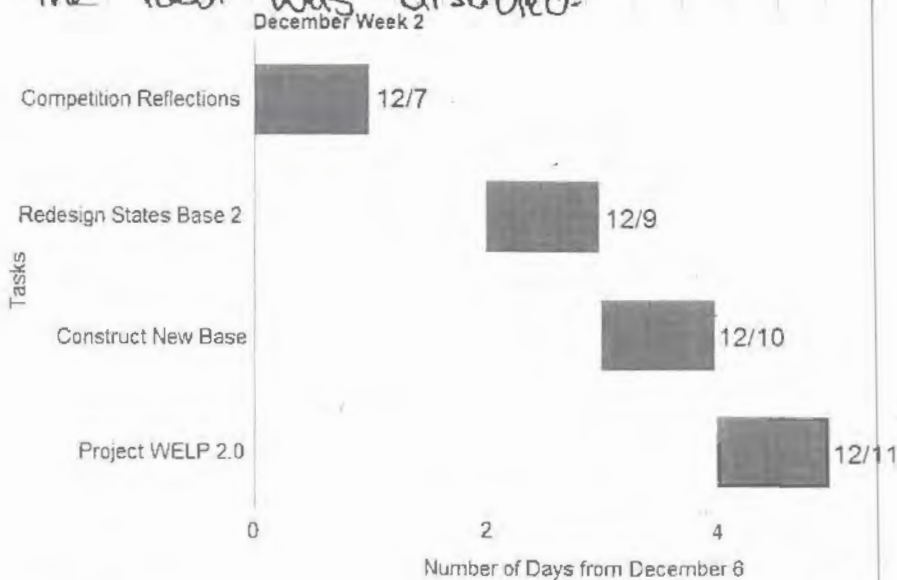

Continued to page

SIGNATURE: *[Signature]* DATE: 12/7/15

DISCLOSED TO AND UNDERSTOOD BY: *[Signature]* DATE: 12/7/15

PROPRIETARY INFORMATION

Bar Shooter Decision Matrix

12/23/16^{AA} 15

• Bar Shooter Decision Matrix

	Speed	Ease of Build	Precision	Room for Error	Compatibility
Short-Range WELP Total Points: 36.5	8 • Although the short-range WELP is fast, the flywheel would take less time to ^{AA} recharge build up speed again.	9.5 • The design is already built, so it would take less time to fix problems.	9 • The short-range WELP is very precise.	5 • If 2 balls are inadvertently intaken into the loading area, the balls will be shot a short distance.	5 • The short-range WELP is heavy and takes up a lot of space. If we decide to build an elevation mechanism after our next competition, this will not be a viable option.
Flywheel (shown on pg. 1-262) Total Points: 42.5	9 • The flywheel would take less time to shoot multiple balls at once.	8.5 • The design is already CADed, so it would take little time to construct it. However, it would still take more time than the already built design.	8 • The design is precise, but not as precise compared to the short range WELP.	8 • If the driver accidentally shoots 2 balls at once without waiting for the flywheel to build up speed again, the ball would land slightly lower, than but it could still land inside the high goal.	9 • The flywheel takes up little space and is light. There is little stress on the motors and there are no parts that would need to be replaced for the competition (i.e. rubber bands).

• We chose the flywheel because of its high speed, room for error, and compatibility. Continued to page 1-268

SIGNATURE

DATE

12/23/16

DISCLOSED TO AND UNDERSTOOD BY

DATE

12/23/16

PROPRIETARY INFORMATION

Build Day 63 / CADD Day 16 (cont.) 12/23/15



Top Intake



Chains that Guide Balls into the Intake



Added C-Channel Coupler on Short-Range WELP

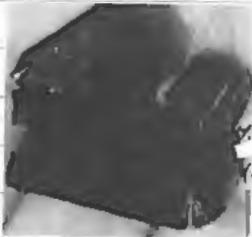

Broken Bearing from 4-Bar



2.3 Sprocket Chain on Transmission

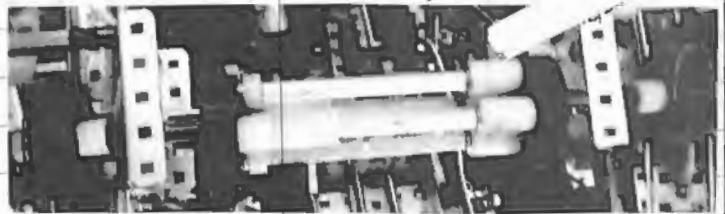

Cylinder Connecting Full-Court WELPs. Note the slip gears' positions (circled in the picture). One gear's polished side is at the top, and the other has teeth on top. This allows us to alternate shots.



Today's Final Product

Continued to page 1-269

SIGNATURE

[Handwritten signature]

DATE

12/23/15

DISCLOSED TO AND UNDERSTOOD BY

[Handwritten signature]

DATE

12/23/15

PROPRIETARY INFORMATION

Build Day (3/CADD Day 16 (cont.)

12/23/15

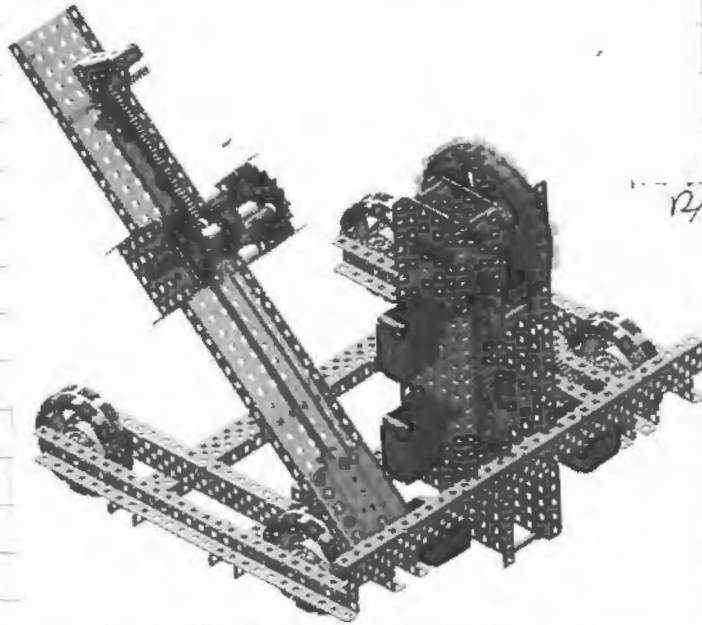

12/23/15

Starting next meeting, we will begin to modify the robot to make the CAD shown above.

- * One aspect of the robot that we plan to make not shown in the CAD is a ratcheting system. A ratchet is used for mechanisms only moving in one direction. The ratchet will prevent the wheel from moving too fast ~~and twisting on~~^{AA} axle for the motor and reduce the effect of the wheels^{AA} effect^{AA} on motor life.

12/23/15

Continued to page

SIGNATURE

DATE

12/23/15

DISCLOSED TO AND UNDERSTOOD BY

DATE

12/23/15

PROPRIETARY INFORMATION

Build Day 64 / CADD Day 17

12/24/15

- Objectives for Today
 - Build Flywheel
 - Test Flywheel
- Today we were able to build a single slip gear Full court shooter that uses 4 motors and proceeded to remove the bar shooter.
- We decided to replace the robot's bar shooter ~~of A~~ with a Fly wheel shooter because the design was much more simpler and completed the same actions with an increased speed. We continued to follow through with this design by mounting the flywheel bar shooter and taking off the second Full court WEP shooter.
- The bar shooter was then tested to reensure our change in design.
- ~~At the end of the day, a full CAD of the new flywheel bar shooter was created. A.A~~



Gear Train

- Next Time
 - Work on Intake
 - Test Intake

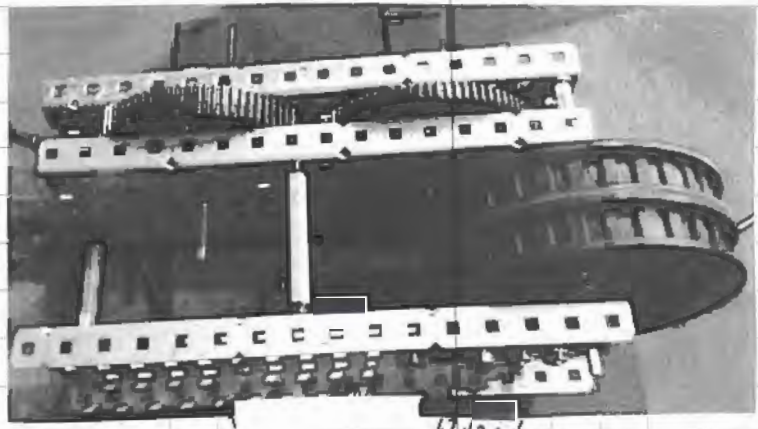

Flywheel Bar Shooter Top View

12/24/15

SIGNATURE

[Handwritten signature]

DATE

12/24/15

Continued to page

DISCLOSED TO AND UNDERSTOOD BY

[Handwritten signature]

DATE

12/24/15

PROPRIETARY INFORMATION

Build Day 6512/25/15

- Objectives for Today
 - Work on Intake
 - Test Intake
 - Today we built a Funnel for the robot's intake and tested how well it functioned afterwards.
 - We then continued to test the new fly wheel bar shooter and fixed any minor changes that needed to be made
 - To test the efficiency of the full court slip gear shooter, we seperated it from the robot. This allowed us to see how well it performed by itself.
 - We also added rubber band mounting ^{^^} slits ^{to ^^} for the full court shooter.
 - Towards the end of the day, we began building the new transmission and plan to continue next meeting.
- Next Time
 - Continue Working on Transmission



Building New Transmission

(Standoff Gear)

Continued to page 1-272

SIGNATURE *[Signature]*

DATE

12/25/15

DISCLOSED TO AND UNDERSTOOD BY

DATE

12/25/15

PROPRIETARY INFORMATION

Build Day 65 (cont.)

12/25/15



12/25/15



12/25/15



12/25/15

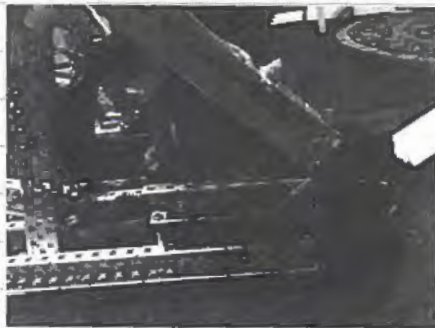

12/25/15



12/25/15

Building New Transmission

12/25/15

Continued to page

SIGNATURE

[Handwritten signature]

DATE

12/25/15

DISCLOSED TO AND UNDERSTOOD BY

[Handwritten initials]

DATE

12/25/15

PROPRIETARY INFORMATION

Skills Competition at Manassas Christian School

1/15/16

- Objective for Today
- Be Ready and Do Well at the Skills Competition!!!
- Today we started the day by practicing how we would load the full-court shooter. At first, we tried having two drive team members alternate ^{place} after placing two balls in the shooter. However, they were unable to determine the time when both balls were placed until they noticed the other member was waiting. Consequently, we had one person load the robot while the other would have a load in both hands, with one hand extended toward the other member. Using this method, ^{the} one member can look for the balls, while the other can take a ball from the same area each time.
- We also utilized a gyro sensor for programming skills. With the gyro, we are able to move to the alliance tiles of the other color accurately.
- However, the gyro code did not work as intended.

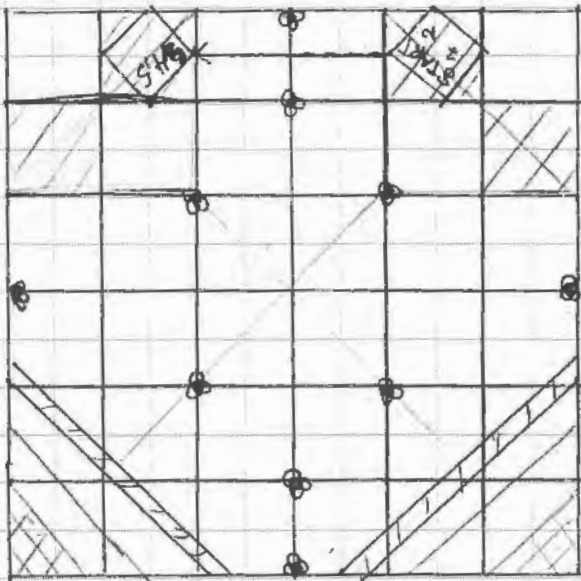

Steps for the Intended Autonomous:

1. ^{Load} Load the robot continuously until there are no more loads left.
2. Turn right.
3. Move Forward.
4. Turn left.
5. Load the robot continuously until ^{there} there are no more loads left.

- However, during Step 2, the robot would not turn all the way, and we would be unable to load the balls.

Continued to page 1-293

SIGNATURE →	DATE 1/15/16
DISCLOSED TO AND UNDERSTOOD BY CA ✓	DATE 1/15/16
PROPRIETARY INFORMATION	

Skills Competition at Manassas Christian School (cont.)

1/15/16

- Next Time
 - Fix Gyro Code
 - Do well at the Competition Tomorrow!

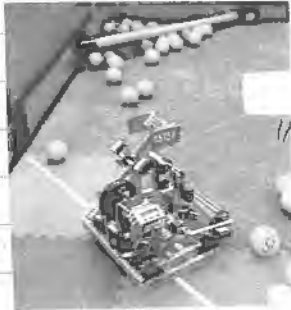

1/15/16

Driving on the Practice Field



1/15/16

Coding the Gyro Sensor



1/15/16

Running Programming Skills

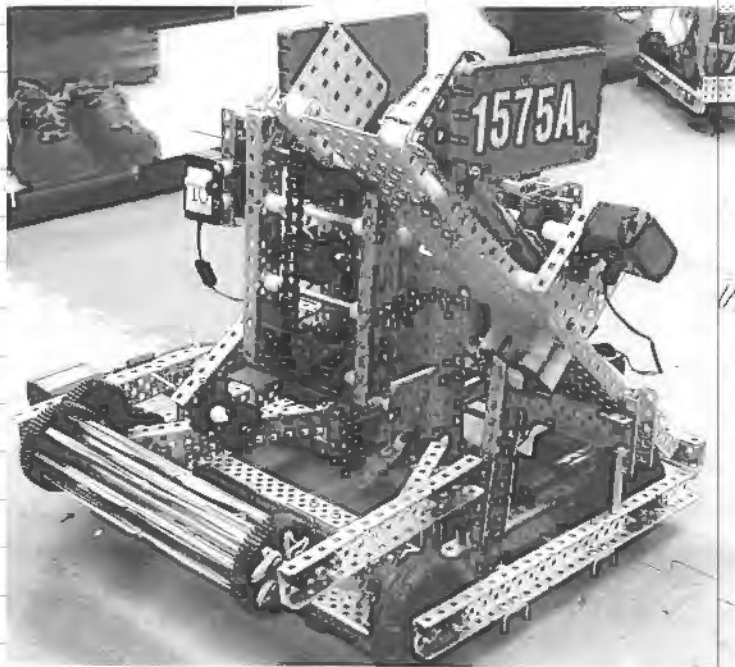

1/15/16

At the end of the day, our highest robot skills score was 206, and our highest programming skills score was 90. After fixing the gyro code, our robot will be ready for tomorrow's competition.

SIGNATURE *[Signature]*

DATE 1/15/16

Continued to page

DISCLOSED TO AND UNDERSTOOD BY *[Signature]*

DATE 1/15/16

PROPRIETARY INFORMATION

January 16th, 2016: USPTO Competition

1/16/16

- Objectives for Today
 - Fix Gyro Code
 - Do well at the competition ~~tomorrow~~ ^{A.A.} today!
- First, we fixed the gyro code. Every time the robot shot, the recoil would cause the robot to slightly turn to the left. Consequently, during programming skills where we had to fire many balls at once, we would start missing the shots after about 25 balls. The gyro code turns the robot back to its original position when the robot turns too far.
- During programming skills, the front intake ~~fell off~~ ^{A.A.} became loose on one side. After skills, we tightened the intake and included checking the intake on the match checklist.
- In one of the matches, our front intake got stuck in another robot's mecanum wheel, and some rubber bands snapped. After we replaced the rubber bands, the intake could function again.
- In one of the matches, the robot started making twitching motions. We realized that this was because we made the margin of error too small. Every time we used the gyro, it would turn slightly past its original position. As a result, the robot would continuously move back and forth but never return to the exact original position. After we increased the margin of error, the robot could shoot without twitching. Although the robot did not return to its exact position, the ~~different~~ ^{A.A.} difference is too little to drastically change the balls' trajectory.
- Next Time
 - Post-Competition Reflection

Continued to page 1-295

SIGNATURE

DATE

1/16/16

DISCLOSED TO AND UNDERSTOOD BY

DATE

1/16/16

PROPRIETARY INFORMATION

January 16th, 2016: USPTO Competition (cont.)

1/16/16

Q3 @ 10:50 ✓ win

a: ~~12B~~ 12B o: 169X, 4061K

Q10 @ 11:25 ✓ win

a: 169Y o: 4061H, 99339

Q13 @ 11:40 ✓ win

a: 12D o: 889Z, 1325W

Q23 @ 1:30 ✓ win

a: 929W o: 0603F, 8086A

Q27 @ 1:50 ✓ win

a: 3623A o: 9849D, 98301

Q35 @ 2:30 ✓ win

a: 6443 o: 169A, 3922A

Q39 @ 2:50 ✓ win

a: 6603F o: 1144, 4061K

This was our match list. We used this to keep track of our schedule and to see which teams we needed to make a strategy with and against.

- The power expander is plugged in.
- Robot is on.
- Controllers are on.
- Controllers are plugged in.
- Robot and ~~controller~~ leads are set up for autonomous.
- Wires not stuck on anything.
- Robot grounded for autonomous
- Rubbands Check
- Intake loose?
- Auton. Select

1/16/16

1/16/16 This was the match checklist we used at the competition. We added tasks for each new problem we faced.



1/16/16

A screw got stuck in the gear during a match.

Continued to page 1-296

SIGNATURE

DATE

DISCLOSED TO AND UNDERSTOOD BY

DATE

PROPRIETARY INFORMATION

January 16th, 2016: USPTO Competition (cont.)

1/16/16

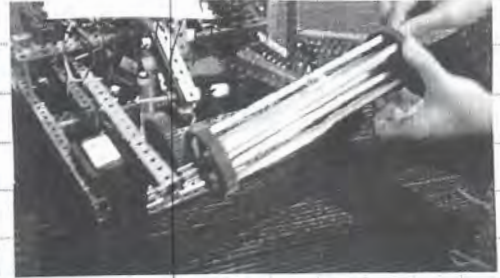

SIGNATURE *[Signature]*

DATE 1/16/16

Continued to page 297

DISCLOSED TO AND UNDERSTOOD BY *[Signature]*

DATE 1/16/16

PROPRIETARY INFORMATION

January 16th, 2016: USPTO Competition (cont.) 1/16/16

VEX		Qualification Rankings			
MID-ATLANTIC REGIONAL NOTHING BUT NET					
Rank	Team #	Name	WPs	SPs	W-L-T
1	1575A	Athena	14	582	7-0-0
2	8086A	Semiconc	12	822	6-1-0
			762		6-1-0

1/16/16



1/16/16

Continued to page

SIGNATURE *[Signature]*

DATE *1/16/16*

DISCLOSED TO AND UNDERSTOOD BY *[Signature]*

DATE *1/16/16*

PROPRIETARY INFORMATION

January 18, 2016: Post-Competition Reflection

1/18/16

• Personal Statements

"Competition-wise, we were lucky, but we should be able to do a little more. We did a lot of last-minute things, so we need to be more well-rounded to be prepared for the next competition."

"The autonomous worked in theory, but not in practice. To fix this, we should try using a laser pointer. We did somewhat well in skills, but our scores could be improved."

"During the competition our overall performance was decent. We helped other teams and our robot worked as expected. We need to improve our judges' interview, however."

"I think we were overall fantastic! We definitely showed a lot of improvement in comparison to our last competition, so that was really impressive. I'm proud of how much we were able to help out other teams and have a good time with them. I think there are some minor issues like lining up for autonomous, but other than that, we were pretty good."

"The Mid-Atlantic competition was probably the best showcase of all the time, thought, and hard work we put into the robot. We were first in both skills and went 7-0. Despite our success, we are finding that we are not scoring as much as we would like to in matches and skills challenges. To improve, we should just hone our skills in driving and perfect the one-minute autonomous."

"I think the USPTO competition went really well; we were all on the same page, and that allowed us to thrive as a collective group. It was a fun tournament, and we just need to focus on the nitpicky things now for our upcoming competitions."

"In general, the competition went well. However, we need to practice lining up the robot for autonomous. The most entertaining part of the day was when ^{we} were resetting the

Continued to page 1-299

SIGNATURE

DATE

1/18/16

DISCLOSED TO AND UNDERSTOOD BY

DATE

1/18/16

PROPRIETARY INFORMATION

January 18, 2016: Post-Competition Reflection (cont.)

1/18/16

• Personal Statements (cont.)

field after a match, and a volunteer working with us said, "Wow, you guys are great field resetters!" Overall, it was a great day.

• Post-Competition Reflection

• There were some aspects of the competition that went well.

• The autonomous was almost fully consistent when the robot was positioned correctly before the start of the match. The new gyro code allowed the robot to shoot without being affected by the recoil of the shots during autonomous skills, robot skills, and matches.

• The base was still very fast compared to the other robots at the competition, even though we switch from a 5:1 gear ratio for speed to a 3:1 gear ratio for speed. The 3:1 gearing is most likely the optimal gear ratio for the base, because it is high enough to be faster than other robots, but low enough to prevent the base from easily shutting down. The smaller size also improved the maneuverability of the robot.

• The WELP full-court shooter was mostly ~~easy~~ consistent and accurate. The flywheel bar shooter was fast and accurate, scoring most of the points we made during matches.

• The intake could quickly gather and store the maximum amount of balls (4 balls) at once.

• However, some aspects of the robot could be improved.

• Due to its light base, the recoil of the shots for the WELP shooter had a greater effect on the robot.

• The rubber band ^{intake} repeatedly got stuck on other robots, causing the robot to be unable to move. When we ^{tried} pulling the robot out, the base died. It also came loose during a match.

• The recoil from the WELP shooter caused the robot to slightly turn to the left with each shot,

Continued to page 1-300

SIGNATURE

DATE

1/18/16

DISCLOSED TO AND UNDERSTOOD BY

DATE

1/18/16

PROPRIETARY INFORMATION

January 18, 2016 Post-Competition Reflection (cont.)

1/18/16

- reducing the accuracy of the shooter.
- The bar shooter's accuracy changed depending on the battery voltage, and we forgot to continuously check the voltage.
- We will take the following steps to resolve the problems listed on pg. 1-299 and above
 - The problem with the recoil (~~shown~~^{A.A.} explained on pg. 1-299) was fixed by the gyro code (explained on pg. 1-294). However, it was not complete at the start of the day, so our results at the competition were still affected. We can easily add changing the battery ^{check AA} on our list.
 - We will tighten all axles and screws on the intake ~~to~~^{to} ~~the~~^{the} ~~robot~~^{robot} that has rubber bands to improve the structural integrity of the robot. We will use a laser pointer to set up the robot accurately for autonomous.
- * At the end of many matches, we cleared the field with a minute to spare. As a result, the robot was idle for the majority of the match. In the future, we plan to create an elevation mechanism to prevent the robot from wasting time; we will be able to increase the robot's efficiency by scoring up to 50 points with the remaining time.

1/18/16

Continued to page

SIGNATURE

[Signature]

DATE

1/18/16

DISCLOSED TO AND UNDERSTOOD BY

[Signature]

DATE

1/18/16

PROPRIETARY INFORMATION

Statistics for USPTO Competition

1/18/16

Competition at USPTO

Rank: 1

Wins - Losses - Ties: 7-0-0

Win Points / Score Points: (14/582)

1/18/16
W

Qualification Matches

Match Number	Red Alliance	Blue Alliance	Scores	Win/Loss for 1575A
3	169X 4061K	1575A 12B	61 137	Win
10	1575A 169Y	4061H 99339	168 121	Win
13	1575A 12D	889Z 1325W	135 28	Win
23	929W 1575A	6603F 8086A	226 167	Win
27	9849D 98301	1575A 3623A	58 131	Win
35	169A 3922A	1575A 6443	116 159	Win
39	4061K 1144	1575A 6603F	31 110	Win
Average			152.3	

1/18/16

SIGNATURE

Continued to page 1-302

DATE

1/18/16

DISCLOSED TO AND UNDERSTOOD BY

DATE

1/18/16

PROPRIETARY INFORMATION

Statistics for USPTO Competition (cont.)

1/18/16

Quarterfinals

Match Number	Red Alliance	Blue Alliance	Scores	Win/Loss for 1575A
1-1	1575A 929W	1325W 12B	233 44	Win
1-2	929W 169X	1325W 12B	204 19	Win
Average			218.5	

Semifinals

1/18/16

Match Number	Red Alliance	Blue Alliance	Scores	Win/Loss for 1575A
1-1	1575A 929W	4061H 3623A	274 104	Win
1-2	1575A 169X	4061H 3922A	195 91	Win
Average			234.5	

1/18/16

Continued to page 2-1

SIGNATURE

[Handwritten Signature]

DATE

1/18/16

DISCLOSED TO AND UNDERSTOOD BY

[Handwritten Signature]

DATE

1/18/16

PROPRIETARY INFORMATION

Build Day 83 / Programming Day 34/16/16

- Objectives for today
 - Test WELP
 - Autonomous

- Today we created the autonomous plans for the 15-second autonomous. The plans are shown below and on the next page. The key can be found on pg. 2-54 for both diagrams.

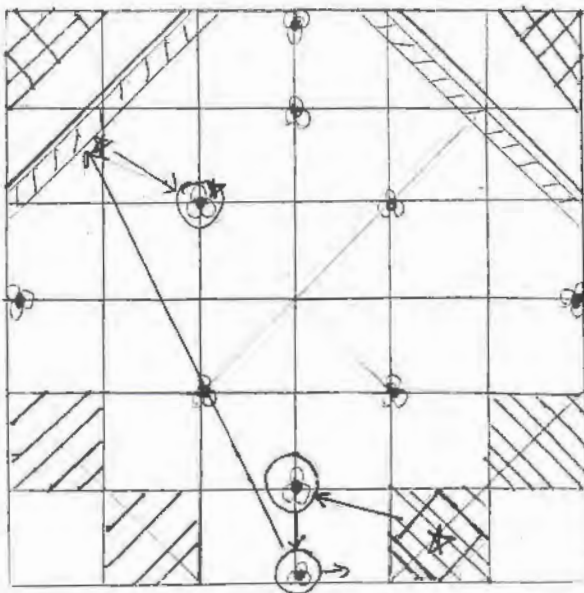

4/16/16

- This is a program that can score a maximum of 60 points and is our riskiest, most aggressive autonomous. This is because when the robot goes to intake the first stack, it immediately moves to push back the balls into our zone, as drawn with the small, noncontiguous arrow. Next, it pushes the stack near the opposing alliance's zone away from their zone, which will prevent them from quickly

scoring. However, the multiple turns before coming close to the opposing alliance's zone ~~that~~^{A.A.} creates less room for error, because if we enter the opposing alliance's zone, we will be ~~disabled~~^{A.A.} lose the autonomous bonus. Hence, this program will only be used if we are absolutely sure of its precision.

4/16/16

Continued to page 2-131

SIGNATURE

C.A. [Signature]

DATE

4/16/16

DISCLOSED TO AND UNDERSTOOD BY

A.W.

DATE

4/16/16

PROPRIETARY INFORMATION

Build Day 83 / Programming Day 31 (cont.)

4/16/16

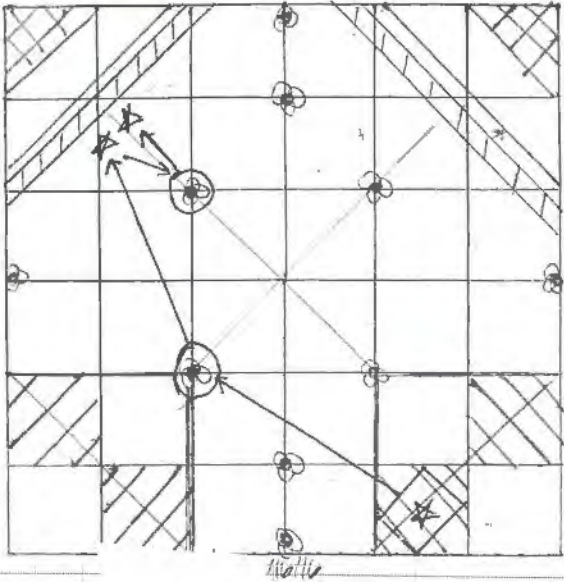

- This next program scores a maximum of 60 points. This will most likely be our primary program, because it balances our desire to score a large amount of points and prevent the other alliance from scoring, while posing less of a risk compared to the program on the previous page. This is because there is only one turn needed near the opposing alliance's zone.

See pg. 2-54 for the diagram's key.

- After we outlined the basic plans for the 15-second autonomous, we began implementing them in the code. We will continue working on the code next meeting.
- Today we also tested the WELP after changing the spacing last meeting. The WELP was much more stable. While testing autonomous, the string snapped, so it was replaced.

- Next Time
- Finish 15-second autonomous

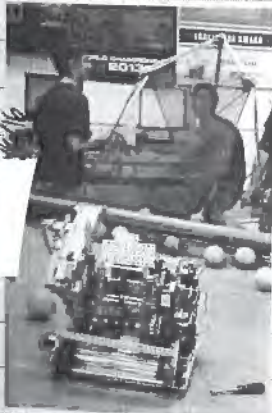

Testing the Autonomous



Replacing the WELP's String

SIGNATURE

Continued to page

DATE

4/16/16

DISCLOSED TO AND UNDERSTOOD BY

DATE

4/16/16

PROPRIETARY INFORMATION

Programming Day 32

4/18/16

- Objective for today
 - finish 15-second autonomouses
- While testing autonomouses, we noticed that the night blue tile can use the same autonomouses as the night red tile. This halved the expected work needed for the autonomouses; consequently, we were able to complete the primary ~~program~~ program for each tile (shown on pg. 2-31).
- The drivers also requested a digital transmission, which would prevent the base from stalling. It reduces the motor power to 60%, so the base does not overexhaust itself. The programmers completed this request.
- Next, we tested the efficiency of our WELP. The ~~test~~^{A.A.} results are shown below.

Shooting Balls into the High Goal			
Trial	Number of Balls in High Goal	Accuracy Rate	Total Time (s)
1	28/32	88%	18.48
2	26/32	81%	16.35
3	26/32	81%	15.21
Average	26.7/32	83.33%	17.3

- The firing rate is $17.3/32 = 0.54$ seconds per ball, which is $0.54 - 0.43 = 0.11$ seconds ~~slower~~^{A.A.} slower than our previous test (shown on pg. 2-106). This is most likely because of the low battery voltage during the first two trials. For the third trial, the total time was much less compared to the first two trials, because the batteries were switched beforehand.
- The accuracy rate is 83.33%, which is $83.33 - 75 = 8.33\%$ more than the previous test (shown on pg. 2-56). The test results demonstrate

Continued to page 2-133

SIGNATURE

DATE

DISCLOSED TO AND UNDERSTOOD BY

DATE

PROPRIETARY INFORMATION 1

Programming Day 32 (cont.)

4/18/16

4/18/16

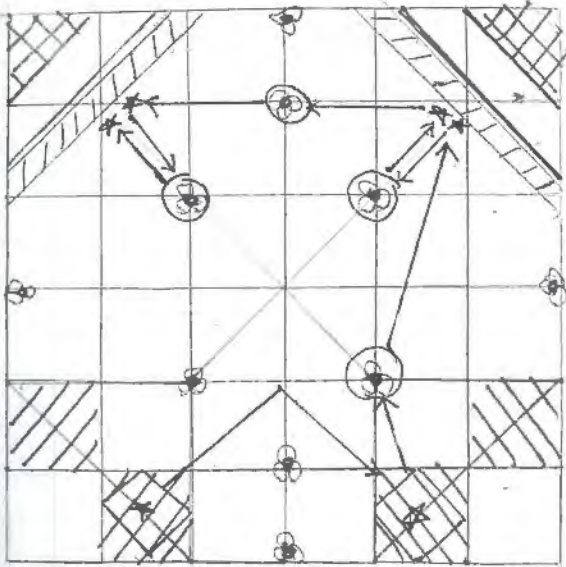

- This is the autonomous that we plan to perfect at worlds. It scores a maximum of 420 points, for programming skills.

See pg. 2-54 for the diagram's key.

- Next time
 - Do well at worlds
 - Perfect Auton Skills

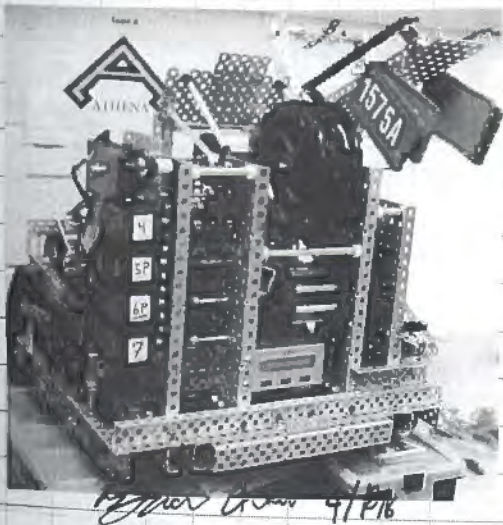

Robot from 4/18/16

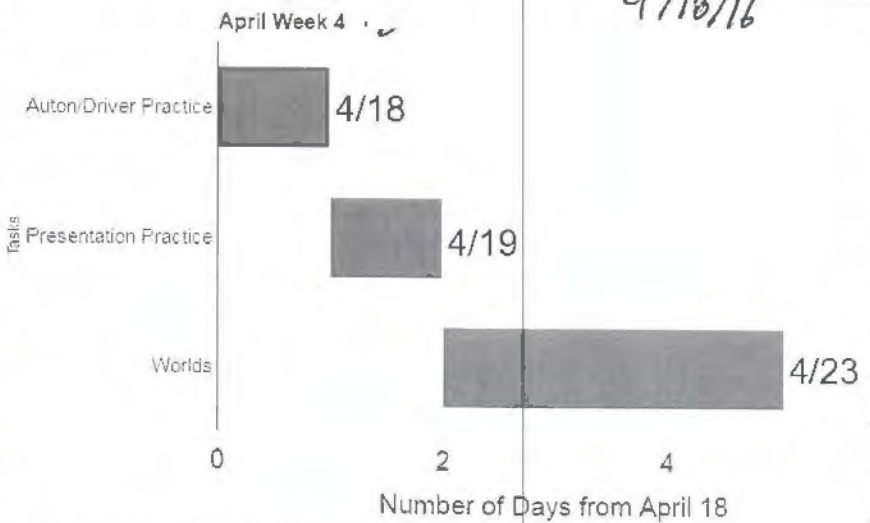

The Final Product! 😊

After today, we are preparing for and competing at worlds!

Continued to page

SIGNATURE

DATE

4/18/16

DISCLOSED TO AND UNDERSTOOD BY

DATE

4/18/16

PROPRIETARY INFORMATION